



windmill
all about fans

An Exclusive Designer Product from **TULLU**green

Designer fan collection 2023

YOUR space
YOUR choice
OUR fans

We are a manufacturing company located in India, serving customers since 1947.

Our brand **TULLU** green is recognised for Quality and Performance across the country.

- + made in India
- + handmade with care
- + Major production exported worldwide
- + in-house research & development team
- + trusted by leading architects & designers
- + available worldwide through our trusted partners



HIGH TORQUE MOTOR



COMPLETE CUSTOMISATION



SOLID WOOD BLADES



RUBBER SEALED PRECISION BEARINGS



EXPORTED WORLDWIDE

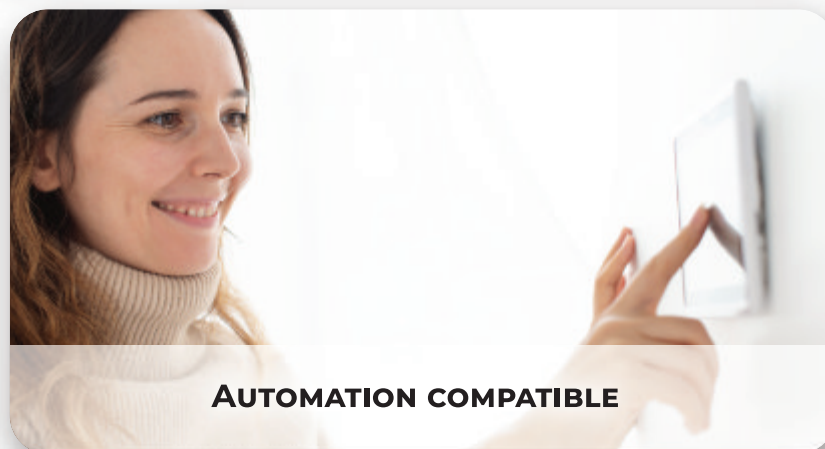

AUTOMATION COMPATIBLE

THERE
ARE MANY
REASONS
WHY
WINDMILL
FANS
ARE THE
BEST
DESIGNER
FANS.

1

FAN SIZE

60 sq. Feet or less

Blade Sweep
900 mm or less

60 to 100 sq. feet

Blade Sweep
upto 1050 mm

100 to 135 sq. feet

Blade Sweep
upto 1200 mm

135 to 200 sq. feet

Blade Sweep
upto 1400 mm

200 sq. Feet or more

Blade Sweep
1500 mm or more
or
multiple fans of
smaller size.

2

MOUNT



Ceiling height 8 feet or less

HUGGER fan
no downrod



Ceiling height 8.5 feet or more

FAN
with downrod



Ceiling Height 10 feet or more

FAN with
ROD EXTENSION



Sloping Mount max. 27 degree rake

FAN with
BALL MOUNTING

3

STYLE



modern



contemporary



cutting edge



heritage



classic

4

CUSTOMISE

STANDARD

Choose from select fan finish combinations

2 - 3 week manufacturing lead time

No customisation charges

CUSTOMISED

Choose from our range of motor & fan blade finishes

4 - 5 week manufacturing lead time

Customisation charges applicable

5

ROD LENGTH

1. Keep Ceiling fan between 8 to 9 feet from the Ground
2. Minimum distance between Fan blade and ceiling should be 7 inches and more for sizes larger than 1200 mm.
3. Downrod Length can be customised to any length
4. Length upto 1.5 meter in single piece
5. Length greater than 1.5 meter in multiples with jointers

FACT

Fans with longer rods have LESSER wobble.

SELECT
THE
RIGHT
FAN FOR
YOUR
SPACE

REVERSE FUNCTION

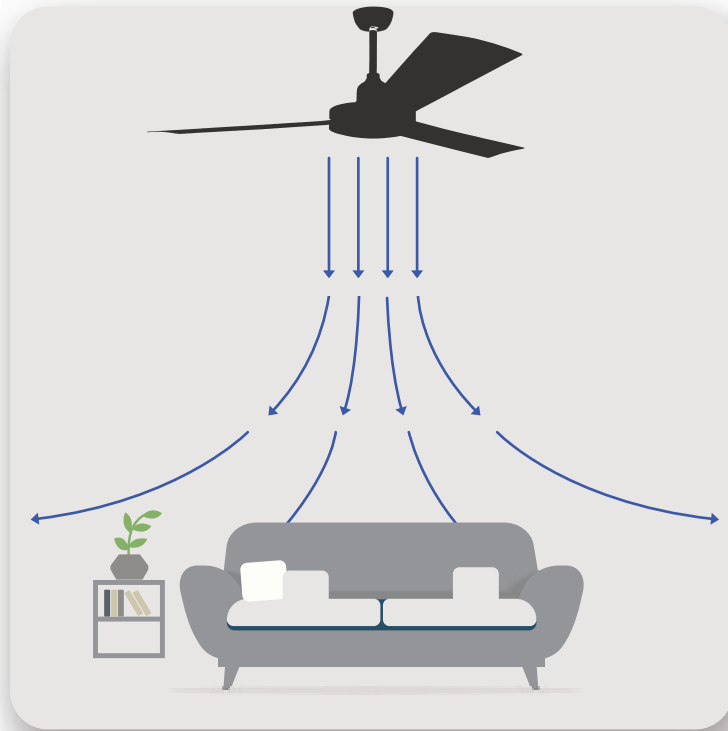

SUMMER OPERATION

clockwise operation pushes air down with a cooling breeze saves cooling cost by supporting air conditioners

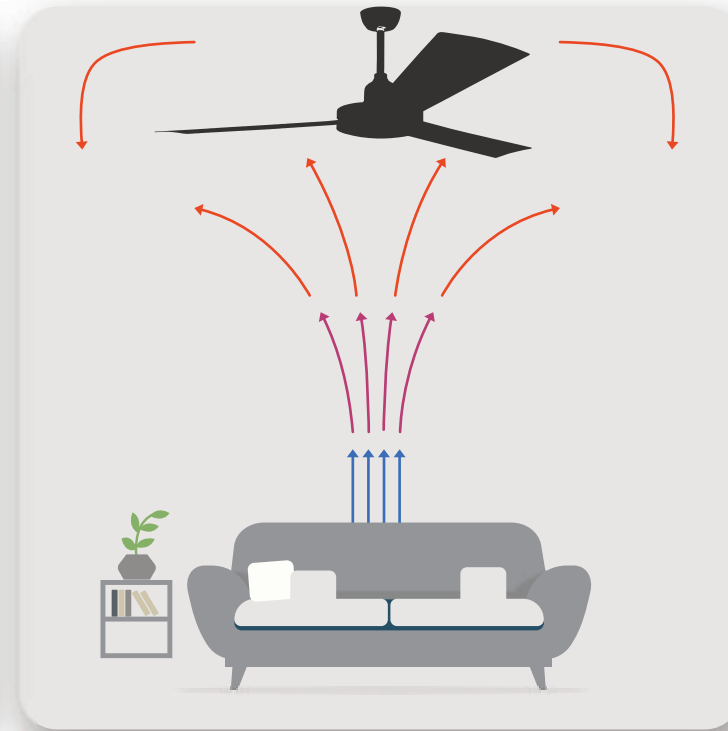

WINTER OPERATION

anti-clockwise operation recirculates warm air trapped on the ceiling down through the walls without creating a breeze. Saves heating cost by eliminating hot air stratification.

ACCESSORIES

- 4 Fan speeds
- Light ON/OFF function (for Fan with Light kits)
- Operate multiple fans with One remote
- Radio control - no need to point at sensor



FAN REMOTE CONTROL

- Solid State Choke type controller
- Extreme Long Life
- Heavy Duty
- No Electronic Parts
- Suits all Models



5 SPEED WALL CONTROLLER

- Save Electricity in Winters
- Pushes trapped HOT Air Down from the ceiling
- Switch to be Manually operated



REVERSE OPERATION

- Down-rods of ANY Length up to 6 feet in Single Length
- Down-rods with Joints in ANY LENGTH

CUSTOM LENGTH RODS

- 16 Watt High Power
- Long Life DIMMABLE driver
- SMD Led with long Life
- Supplied with 3 Speed remote controller (to operate fan and light separately)

LED LIGHT KIT

- Special Mount for raked / slant ceilings
- Can mount upto 25 Degree slope
- Remote Control Ready
- Ceiling must take load of 50 Kgs. min.



SLOPE ROOF MOUNT

HUGGER FANS

WHEN TO USE



LOW CEILING HEIGHT SPACES

Spaces where available height is less than 2.5 meters (8 feet) is ideal for Hugger fans. For rooms with ceiling height more than 3 meter (9 feet) Rod type fan is recommended for better performance

STANDARD MOUNTING

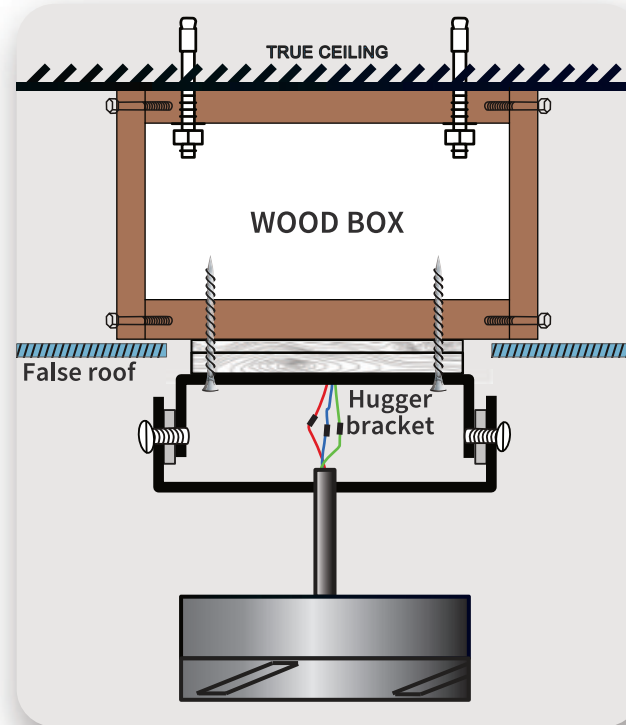

FAN BOX MOUNTING

Wood box is provisioned inside the false roof which bears the load of Hugger fan. This must be done during the false roof installation. *Hugger can also be installed directly on True Ceiling when false roof is not present.*

OPTIONAL MOUNTING

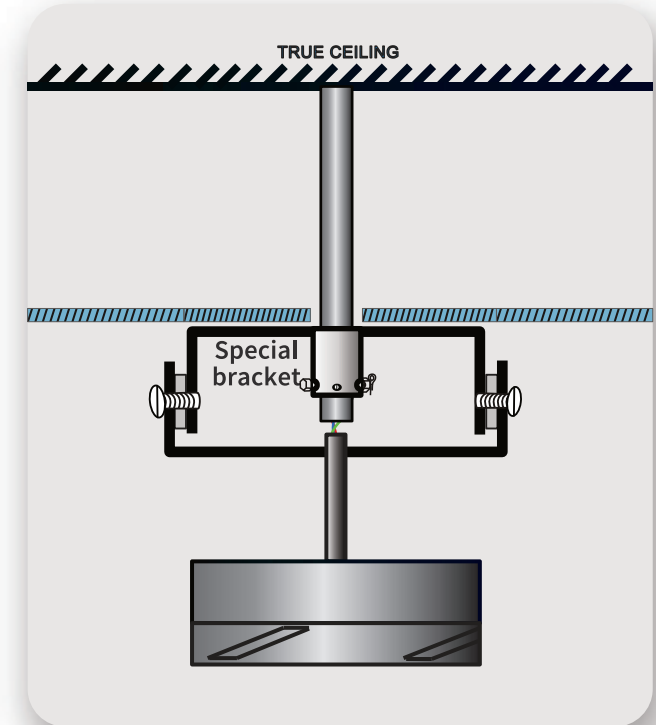

FAN ROD MOUNTING

When a market fan rod is present, Hugger fans can be installed with a Special Bracket. This method requires more effort to install. Fan performance or aesthetics are not affected.

(chargeable extra)

HOME AUTOMATION

When it comes to automation-compatible ceiling fans, there are few important considerations to keep in mind. In addition to the motor type and control options, it's also important to consider the type of speed controller that you'll be using, as well as any compatibility issues that may arise when using automation systems.

- Stepped type speed controllers are preferred
- Triac dimmer speed controllers are not recommended, they can cause a humming sound in the fan.
- If using an automation speed control, it's important to disconnect any remote controls that are currently in use to avoid interference between the two systems.
- Similarly, if using a remote control for the ceiling fan, it's important to disconnect any other speed controllers that are currently in use.
- Not all automation systems provide the same number of speed settings, so it's important to choose a system that offers the level of control desired.

USE CASE 1

Home automation with fan speed controller

- Choose Windmill fans AC Motor without Remote controller
- Fans connected to Automation fan speed controller will control the fan speeds as per the system capability.
- NOTE: All Automation system speed control settings are programmed differently, fans may run higher or slower depending on the speed settings. Windmill fans cannot do anything to control this.
- Reverse operation if opted must be switched manually. It cannot be automation controlled.

USE CASE 2

Home automation with Fan ON/OFF (No Automation speed controller)

- Select any Windmill Fan model WITH Remote speed control
- Fan ON/OFF will work with Automation system and speed can be controlled with remote.
- Windmill Fan remotes have LAST OPERATION MEMORY , so when automation turns on the fan, it will automatically run at last set speed.
- Reverse operation if opted must be switched manually. It cannot be automation controlled.

USE CASE 3

Home automation with IR (Infra-red) or RF (Radio Freq.) Blaster

- Select any Windmill Fan model WITH Remote speed control. Please ensure RF or IR is mentioned in the Order sheet. Fans will be installed with the same receiver.
- IR or RF blaster can be trained/learn the operating frequencies of Windmill remote.
- Once trained/learn , hand remotes to be kept aside and fans will operate on Automation system as per the system capability.
- Reverse operation if opted must be switched manually. It cannot be automation controlled.



1 → Airnautik



9 → Asana Neo



17 → Colonia



2 → Airxone



10 → Asana Hugger



18 → Colonial Wall



3 → Airxone hugger



11 → Barollo Ceiling



19 → Curtiss



4 → Airxone LED



12 → Barollo Leaf



20 → Curtiss Jr.



5 → Amalfi



13 → Barollo



21 → Generation



6 → Amante



14 → Belize



7 → Antonov



15 → Bijou



22 → Heritage 1910



8 → Asana



16 → Bijou Hugger



23 → Heritage 1914



24 → Heritage 1925



31 → Sabre



25 → Hornet



32 → Scepter



26 → Industrie



33 → Spitfire



27 → Mareilly



34 → Spitfire Hugger



28 → Modena



35 → Stark



29 → Persia



36 → Stealth



30 → Rockefeller



37 → Stealth Hugger

INDEX



38 → Classico



39 → Riviera
(Indoor)



40 → Riviera Mark 2
(Outdoor)



41 → Tripod

42 → Gallery

46 → Custom Fan Finishes

47 → Model Wise Customisation Options

900 mm. 1050 mm. 1200 mm. 1300 mm.

Tech specs

Power:	60 watt	70 watt	75 watt	75 watt
Airflow:	2500 CFM	4500 CFM	5900 CFM	6500 CFM

Standard features

AC Motor
Fully compatible with Automation systems

Optional features

4 speed RF Remote control

Suitable mounting

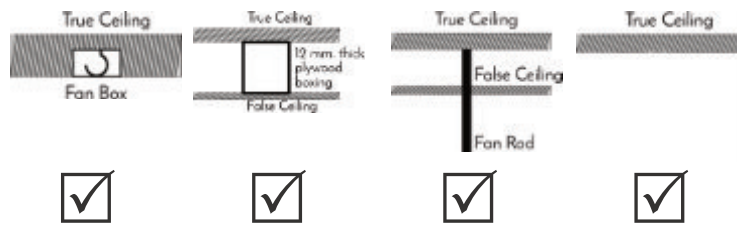

Dimensions



Matt white

48
INCH
1200 MM

Custom finish



Matt black
Teak laminate wood Blades
(Walnut matt)

48
INCH
1200 MM

Custom finish



Airnautik

Modern bold design with smooth curves.

Screw-less blade look with multiple customisation options.

Rugged Die-Cast Aluminium construction, Powered by a 16 Pole Super cool motor, designed to perform for a lifetime

900 mm. 1050 mm. 1200 mm. 1300 mm.

Tech specs

Power: 60 watt 70 watt 75 watt 75 watt
 Airflow: 2500 CFM 4500 CFM 5900 CFM 6500 CFM

Standard features

AC Motor
 Fully compatible with Automation systems

Optional features

4 speed RF Remote control
 Reversible operation (Summer / Winter)
 LED Light with remote control

Suitable mounting

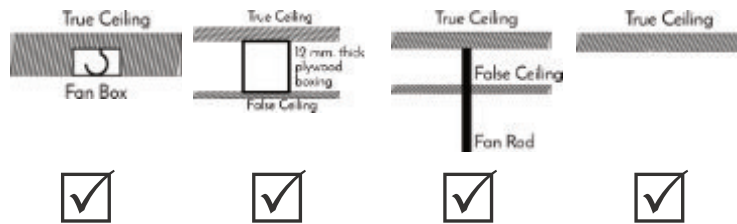

Dimensions



Matt white

36 INCH 900 MM 42 INCH 1050 MM 48 INCH 1200 MM

Standard finish



Matt black

36 INCH 900 MM 42 INCH 1050 MM 48 INCH 1200 MM

Standard finish



**Matt pewter
 Teak laminate wood
 (Walnut Matt)**

36 INCH 900 MM 42 INCH 1050 MM 48 INCH 1200 MM

Standard finish



**Oil rubbed bronze
 Teak laminate wood
 (Walnut Matt)**

36 INCH 900 MM 42 INCH 1050 MM 48 INCH 1200 MM

Standard finish



Airxone

Sophisticated and modern design, clean Screw-less look with three Blades.

Rugged Die-Cast Aluminium construction, Powered by a 16 Pole.

Super cool reversible motor, designed to perform for a lifetime.

900 mm. 1050 mm. 1200 mm. 1300 mm.

Tech specs

Power:	60 watt	70 watt	75 watt	75 watt
Airflow:	2500 CFM	4500 CFM	5900 CFM	6500 CFM

Standard features

AC Motor
Fully compatible with Automation systems

Optional features

4 speed RF Remote control
LED light with Remote control

Suitable mounting

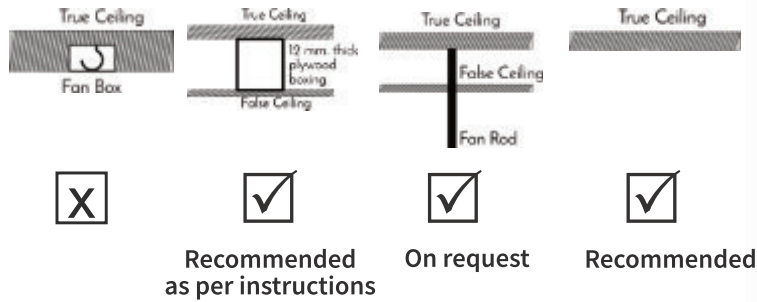

Dimensions

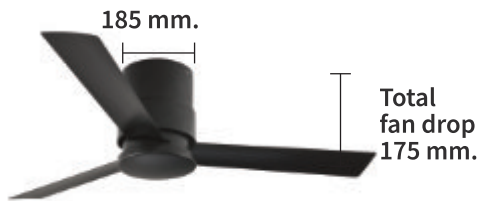

Matt pewter
Teak laminate wood blades
(Walnut Matt)

36 INCH 900 MM 42 INCH 1050 MM 48 INCH 1200 MM

Standard finish



Matt White

36 INCH 900 MM 42 INCH 1050 MM 48 INCH 1200 MM

Standard finish



Matt black

36 INCH 900 MM 42 INCH 1050 MM 48 INCH 1200 MM

Standard finish



Oil rubbed bronze
Teak laminate wood blades
(Walnut Matt)

36 INCH 900 MM 42 INCH 1050 MM 48 INCH 1200 MM

Standard finish



Airxone hugger

Sophisticated and modern design, clean Screw-less look with three Blades.

Rugged Die-Cast Aluminium construction, Powered by a 16 Pole Super cool reversible motor, designed to perform for a lifetime.

HUGGER (Flush Ceiling Mounting) designed to install ceiling fan for Low Height ceilings, without compromise on air delivery



Standard features

18 Watt LED

Remote control with multiple fan speed and Light ON/OFF

NOTE: Airxone LED is a different model. Airxone cannot be converted/retro-fitted with LED.

All technical, mounting, finish specifications remain same as Airxone.

Dimensions

Supplied
downrod
200 mm.

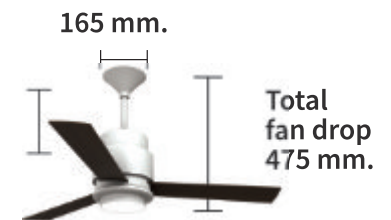



Airxone hugger led

Standard features

18 Watt LED

Remote control with multiple fan speed and Light ON/OFF

NOTE: Airxone Hugger LED is a different model. Airxone Hugger cannot be converted/retro-fitted with LED.

All technical, mounting, finish specifications remain same as Airxone Hugger

Dimensions

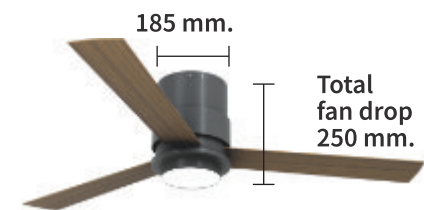

900 mm. 1050 mm. 1200 mm. 1300 mm.

Tech specs

Power: 60 watt 70 watt 75 watt 75 watt
 Airflow: 2500 CFM 4500 CFM 5900 CFM 6500 CFM

Standard features

AC Motor
 Fully compatible with Automation systems

Optional features

4 speed RF Remote control
 Reversible operation (Summer / Winter)

Suitable mounting

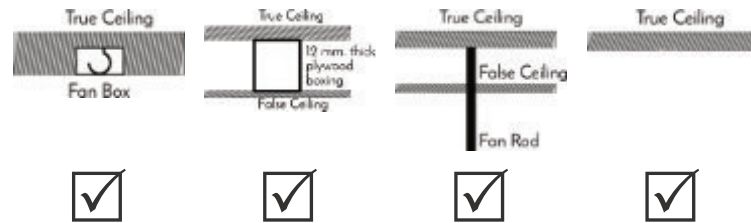

Dimensions

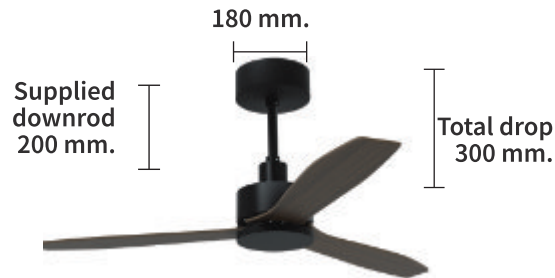

Matt black
Teak laminate wood blade
(Walnut Matt)

42 INCH 1050 MM 48 INCH 1200 MM

Standard finish



Oil rubbed bronze
Teak laminate wood blade
(Walnut Matt)

42 INCH 1050 MM 48 INCH 1200 MM

Standard finish



Matt Pewter
Teak laminate wood blade
(Walnut Matt)

42 INCH 1050 MM 48 INCH 1200 MM

Standard finish



Amalfi

Like the pristine and surreal beaches of Italy, a fan design inspired from the word pure. Simplicity and elegance in its purest form; this design can compliment any style of decoration.

Modern, Contemporary and Classic all work well with Amalfi.

1050 mm. 1180 mm.

Tech specs

Power: 60 watt 65 watt
Airflow: 5000 CFM 6300 CFM

Standard features

AC Motor
Fully compatible with Automation systems

Optional features

4 speed RF Remote control
Reversible operation (Summer / Winter)

Suitable mounting

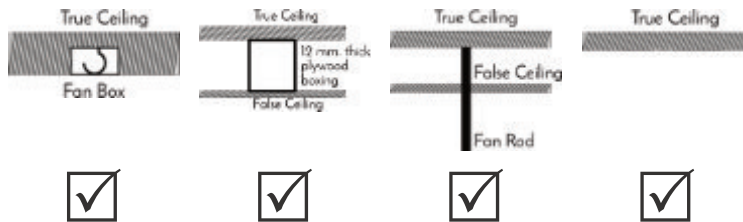

Dimensions

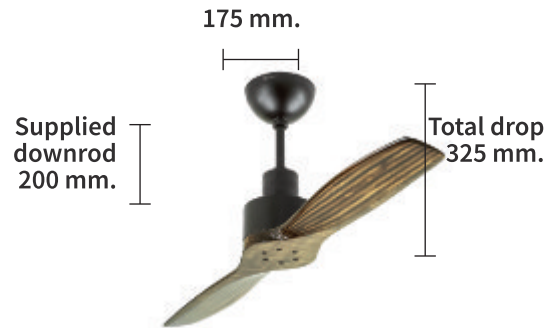

**Matt Black
Birchwood prop.
(Walnut Gloss)**

47
INCH
1180 MM

Standard finish



**Oil Rubbed Bronze
Birchwood prop.
(Walnut Gloss)**

47
INCH
1180 MM

Standard finish



Amante

Elegance and attitude. Twin propeller crafted from the single block of Birchwood.

Smooth natural feel airflow due to natural cutting of air and twin blades. Near silent operation on high speeds makes this fan ideal for corner offices, bedrooms and work from home spaces.

Handcrafted and hand-polished in premium walnut glossy finish

1300 mm. 1400 mm. 1800 mm.

Tech specs

Power: 67 watt 75 watt 90 watt
Airflow: 8600 CFM 9500 CFM 10000 CFM

Standard features

AC Motor
Fully compatible with Automation systems

Optional features

4 speed RF Remote control
Reversible operation (Summer / Winter)

Suitable mounting

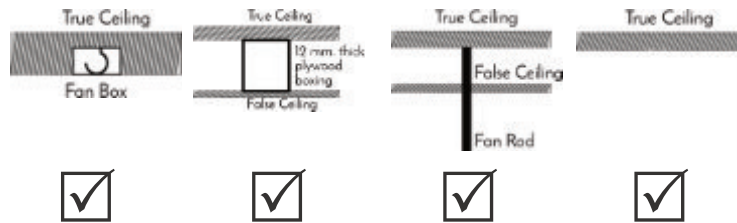

Dimensions



Polished Aluminium
Birchwood propellers
(Dark Walnut matt)

52
INCH
1300 MM

Custom finish



Polished Aluminium
Birchwood propellers
(Matt Black)

52
INCH
1300 MM

Custom finish



Antonov

Made out of Air plane propellers, new motor design with enough air to lift your spirits.

Design so unique it will be noticed. All of this without making a sound.

ANTONOV - Aptly named after an Aviation Legend.

900 mm. 1200 mm. 1400 mm. 1500 mm.

Tech specs

Power:	60 watt	75 watt	75 watt	85 watt
Airflow:	4500 CFM	6800 CFM	8000 CFM	8500 CFM

Standard features

AC Motor
Fully compatible with Automation systems

Optional features

4 speed RF Remote control
Reversible operation (Summer / Winter)

Suitable mounting

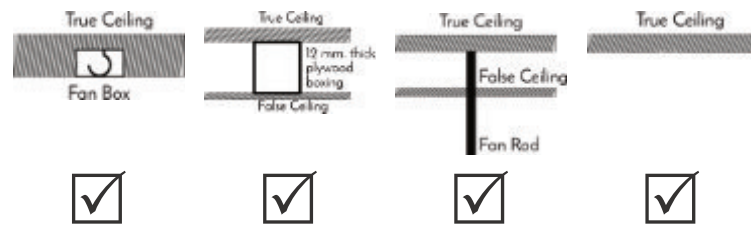

Dimensions



Matt white

36 INCH 900 MM	48 INCH 1200 MM	56 INCH 1400 MM
----------------------	-----------------------	-----------------------

Standard finish



Matt black

36 INCH 900 MM	48 INCH 1200 MM	56 INCH 1400 MM
----------------------	-----------------------	-----------------------

Standard finish



**Matt Black
Teak laminate wood
(Walnut matt)**

36 INCH 900 MM	48 INCH 1200 MM	56 INCH 1400 MM
----------------------	-----------------------	-----------------------

Standard finish



**Matt pewter
Teak laminate wood
Walnut matt)**

36 INCH 900 MM	48 INCH 1200 MM	56 INCH 1400 MM
----------------------	-----------------------	-----------------------

Standard finish



Asana

“ Simple is Sophisticated “, clean Screw-less look with three Blades, with flexibility to add LED light kit.

Solid Teak wood blades to change the look of the fan completely.

Rugged Die-Cast Aluminium construction, Powered by a 18 Pole Super cool reversible motor, designed to perform for a lifetime.

1200 mm. 1400 mm. 1500 mm. 1600 mm.

Tech specs

Power :	70 watt	80 watt	85 watt	90 watt
Airflow :	6500 CFM	7500 CFM	8000 CFM	8500 CFM

Standard features

AC Motor
Fully compatible with Automation systems

Optional features

4 speed RF Remote control
Reversible operation (Summer / Winter)

Suitable mounting

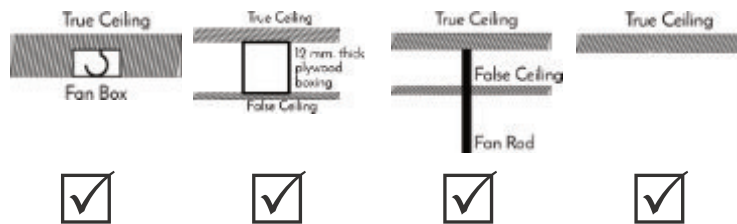

Dimensions

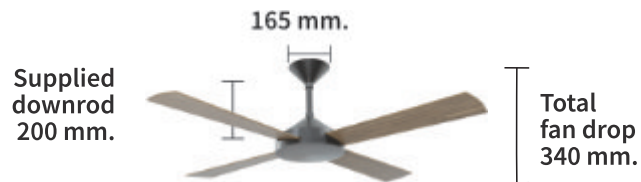

Matt Pewter

48 INCH 1200 MM
56 INCH 1400 MM

Standard finish



Matt black

48 INCH 1200 MM
56 INCH 1400 MM

Standard finish



Matt white

48 INCH 1200 MM
56 INCH 1400 MM

Standard finish



Matt white wood finish metal blades

48 INCH 1200 MM
56 INCH 1400 MM

Standard finish



Matt black wood finish metal blades

48 INCH 1200 MM
56 INCH 1400 MM

Standard finish



Asana neo

A fan designed for Large Spaces with minimal design elements, straight lines and organic shapes.

Light blades enable large sweep size“ Simple is Sophisticated “, clean Screw-less look.
FOUR Blades enhances this models aesthetically pleasing and balanced feel.

Die-Cast Aluminium construction with 18 Pole Super Heavy Duty Motor. Suitable for the most demanding applications.

900 mm. 1050 mm. 1200 mm. 1300 mm.

Tech specs

Power:	60 watt	60 watt	75 watt	80 watt
Airflow:	4500 CFM	5500 CFM	6800 CFM	7300 CFM

Standard features

AC Motor
Fully compatible with Automation systems

Optional features

4 speed RF Remote control

Suitable mounting

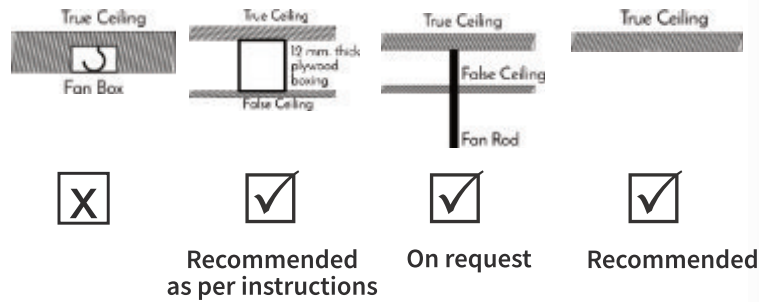

Dimensions

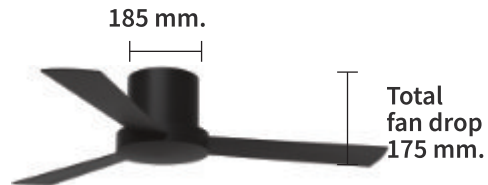

Matt white

36 INCH 900 MM	42 INCH 1050 MM	48 INCH 1200 MM
----------------------	-----------------------	-----------------------

Standard finish



Matt Black

36 INCH 900 MM	42 INCH 1050 MM	48 INCH 1200 MM
----------------------	-----------------------	-----------------------

Standard finish



**Matt Pewter
Teak laminate wood
(Walnut matt)**

36 INCH 900 MM	42 INCH 1050 MM	48 INCH 1200 MM
----------------------	-----------------------	-----------------------

Standard finish



**Matt Black
Teak laminate wood
(Walnut matt)**

36 INCH 900 MM	42 INCH 1050 MM	48 INCH 1200 MM
----------------------	-----------------------	-----------------------

Standard finish



Asana hugger

HUGGER (Flush Ceiling Mounting) designed to install ceiling fan for Low Height ceilings, without compromise on air delivery

“ Simple is Sophisticated “ , clean Screw-less look with three Blades.

Solid Teak wood blades to change the look of the fan completely.

400 mm. 450 mm. 550 mm.

Tech specs

Power: 70 watt 80 watt 85 watt
 Airflow: 3900 CFM 4175 CFM 4500 CFM

Standard features

AC Motor
 3 speed controller (pull chain)
 Fully compatible with Automation systems

Optional features

4 speed RF Remote control

Suitable mounting

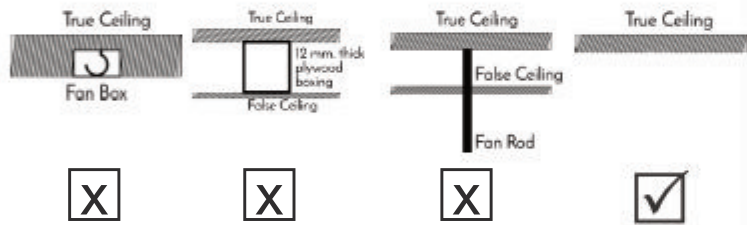

Wall mounted / Can also be installed on Ceiling
 (refer to installation guide)

Dimensions

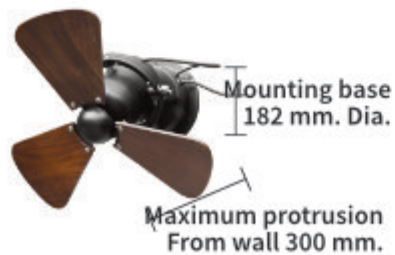

Matt Black
 Solid teak wood blades
 (Walnut Matt finish)

18 INCH 450 MM
 22 INCH 550 MM

Standard finish



Antique Bronze
 Solid Teak wood blades
 (Walnut Matt finish)

18 INCH 450 MM
 22 INCH 550 MM

Standard finish



Barollo wall

Like the greatest wine in Italy, comes the most elegant Ceiling fan.

Solid natural Teak blades, guard-less design, 3 speed inbuilt speed regulator,
360 degree swivel (manual) ensures adaptability to any space.

Designed to inspire.

450 mm. 550 mm.

Tech specs

Power: 80 watt 85 watt
Airflow: 3800 CFM 4300 CFM

Standard features

AC Motor
3 speed controller (pull chain)
Fully compatible with Automation systems

Optional features

4 speed RF Remote control

Suitable mounting

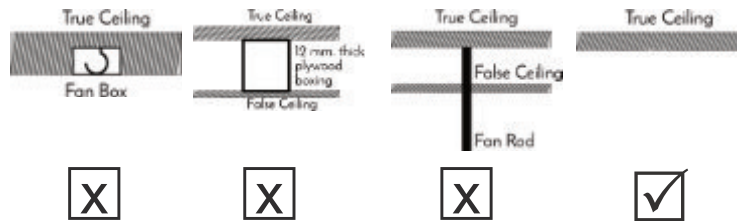

Wall mounted / Can also be installed on Ceiling
(refer to installation guide)

Dimensions

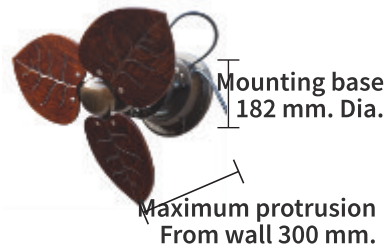

Antique Bronze
Teak laminate wood blades
(Walnut Matt finish)

18
INCH
450 MM

22
INCH
550 MM

Standard finish



Barollo leaf

Reinventing Barollo with tropical leaf blades.
Intricately carved veins add great depth and visual appeal to the leaf blade design.

Guard-less design, 3 speed inbuilt speed regulator, 360 degree swivel ensures adaptability to any space.

Re-Designed to inspire.

400 mm. 450 mm. 550 mm.

Tech specs

Power: 70 watt 80 watt 85 watt
Airflow: 3900 CFM 4175 CFM 4500 CFM

Standard features

AC Motor
Fully compatible with Automation systems

Optional features

4 speed RF Remote control

Suitable mounting

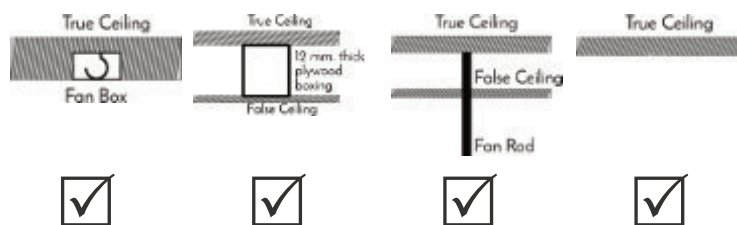

Dimensions

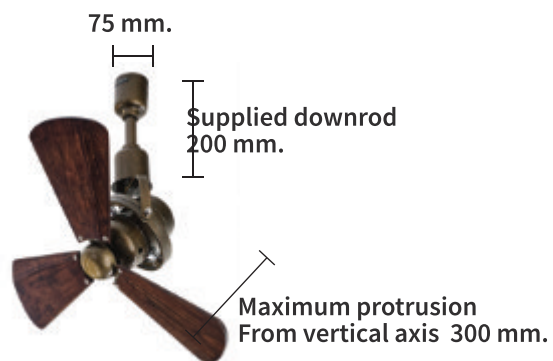

Antique bronze
Solid teak wood blades
(Walnut Matt finish)

18
INCH
450 MM

22
INCH
550 MM

Standard finish



Barollo ceiling

Like the greatest wine in Italy, comes the most elegant Ceiling fan.

18 inch Solid natural Teak blades, guard-less design. 360 degree swivel ensures adaptability to any space.

Designed to inspire.

900 mm. 1050 mm. 1200 mm. 1300 mm.

Tech specs

Power: 60 watt 60 watt 75 watt 80 watt
Airflow: 4500 CFM 5500 CFM 6800 CFM 7300 CFM

Standard features

AC Motor
Fully compatible with Automation systems

Optional features

4 speed RF Remote control
Reversible operation (Summer / Winter)

Suitable mounting

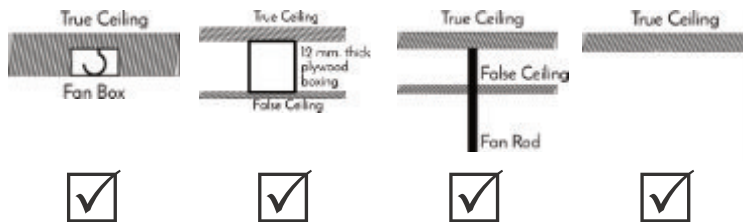

Dimensions



Antique bronze

52
INCH
1300 MM

Custom finish



Matt black

42
INCH
1050 MM

Custom finish



Belize

An elegant design which is Elegantly classic as well as Tropical.

Large body and smooth edges makes this fan blend with any decorative style.

Large air delivery guaranteed along with subtle style and awe !

600 mm. 900 mm.

Tech specs

Power: 58 watt 64 watt
Airflow: 1785 CFM 2000 CFM

Standard features

AC Motor
Fully compatible with Automation systems

Optional features

4 speed RF Remote control
Reversible operation (Summer / Winter)

Suitable mounting

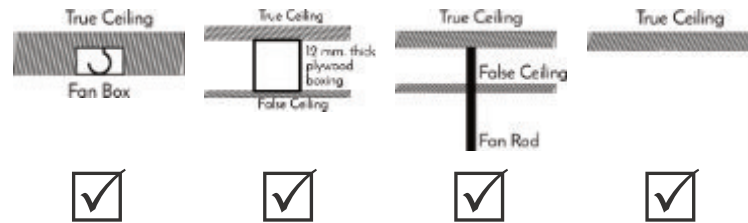

Dimensions



Matt Black

24 INCH 600 MM
36 INCH 900 MM

Standard finish



Matt White

24 INCH 600 MM
36 INCH 900 MM

Standard finish



Bijou

Simplicity and elegance in a small package.

Bijou “small” is specially designed for small spaces. Moisture sealed motor for damp locations.

Powerhouse motor churns out huge volumes of air with ease.
This high speed fan ideal for Wardrobes, Bathrooms, patios and balconies.

600 mm. 900 mm.

Tech specs

Power: 54 watt 59 watt
Airflow: 1785 CFM 2000 CFM

Standard features

AC Motor
Fully compatible with Automation systems

Optional features

4 speed RF remote control

Suitable mounting

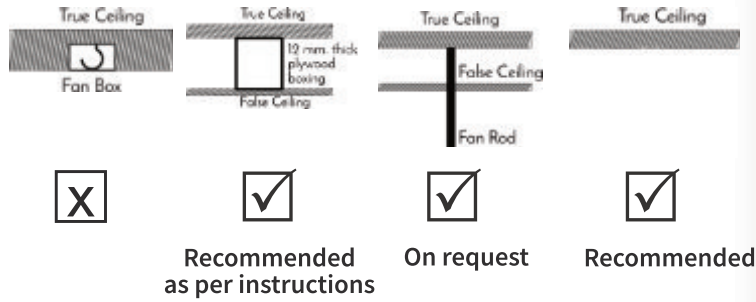

Dimensions

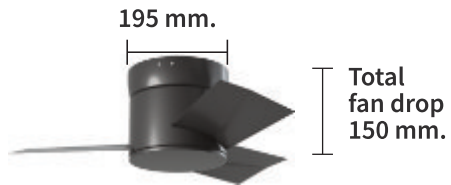

Matt white

24 INCH 600 MM 36 INCH 900 MM

Standard finish



Matt black

24 INCH 600 MM 36 INCH 900 MM

Standard finish

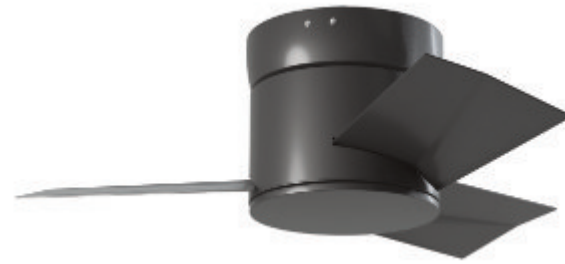

Matt pewter

24 INCH 600 MM 36 INCH 900 MM

Custom finish



Bijou hugger

HUGGER (Flush Ceiling Mounting) designed to install ceiling fan for Low Height ceilings, without compromise on air delivery.

Bijou meaning “Small” now redesigned for bathrooms and closets with Low ceiling spaces.

Powerhouse motor with minimal fan drop makes this a perfect choice for your space.

1200 mm. 1400 mm. 1500 mm.

Tech specs

Power: 65 watt 75 watt 80 watt
Airflow: 7000 CFM 9500 CFM 10500 CFM

Standard features

AC Motor
Fully compatible with Automation systems

Optional features

4 speed RF Remote control
Reversible operation (Summer / Winter)

Suitable mounting

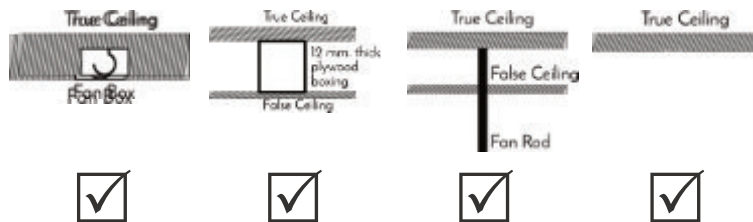

Dimensions



Matt black
Wood finish metal blades

48
INCH
1200 MM

56
INCH
1400 MM

Standard finish



Matt white

48
INCH
1200 MM

56
INCH
1400 MM

Standard finish



Colonial

The Original Colonial Ceiling fan with an internationally acclaimed design.

These can be seen in French Villas, beach houses, Cafe's etc. Wide blades, silent motor and performance to last a lifetime.

Unlimited combinations of colours, finish and Material; this fan is a Interior designers delight.

300 mm. 400 mm.

Tech specs

Power: 40 watt 73 watt
Airflow: 1200 CFM 1800 CFM

Standard features

AC Motor
Fully compatible with Automation systems

Suitable mounting

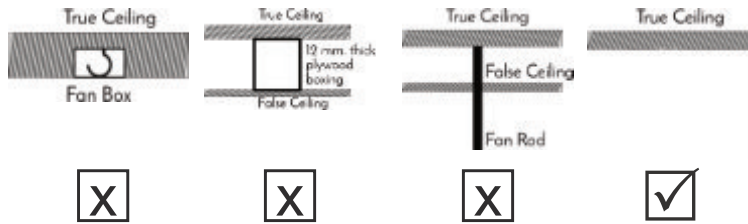

Wall mounted fan / Can also be installed on Ceiling
(refer to installation guide)

Dimensions

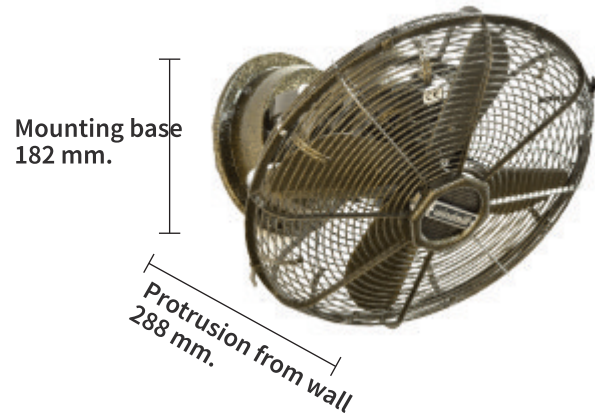

Antique bronze

12 INCH 300 MM 16 INCH 400 MM

Standard finish



Cabin



A Powerful, wall or ceiling mounted fan.

These are designed, keeping in mind small shops, store rooms ,counters, booths etc. where space is a constraint, this fan can be mounted anywhere.

Three Speed setting with Pull Chain, Solid State Choke Speed Control.

1300 mm.

Tech specs

Power: 62 watt

Airflow: 8500

Standard features

AC Motor

Fully compatible with Automation systems

Optional features

4 speed RF Remote control

Reversible operation (Summer / Winter)

Suitable mounting

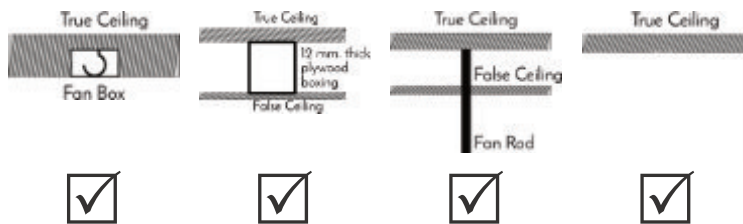

Dimensions



Matt pewter

52
INCH
1300 MM

Standard finish



Matt white

52
INCH
1300 MM

Standard finish



Curtiss

Designed and engineered for a sleek & modern contemporary feel.

It has angled blades that produce a wider air spread pattern and make it perfect for large rooms.

Near silent operation on lower speeds makes this fan ideal for corner offices, bedrooms and work from home spaces.

600 mm. 900 mm.

Tech specs

Power: 58 watt 64 watt
Airflow: 1800 CFM 2000 CFM

Standard features

AC Motor
Fully compatible with Automation systems

Optional features

4 speed RF Remote control
Reversible operation (Summer / Winter)

Suitable mounting

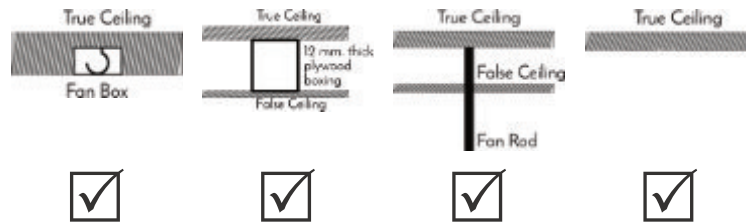

Dimensions

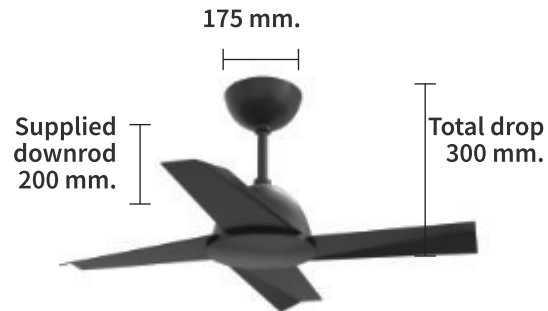

Matt Pewter

24 INCH
600 MM 36 INCH
900 MM

Standard finish



Matt White

24 INCH
600 MM 36 INCH
900 MM

Standard finish



Curtiss Jr.

Designed and engineered for a sleek modern contemporary feel.

It has wide angled blades that produce a wider air spread pattern and make it perfect for small rooms or studio spaces. High speed moisture proof motor makes this fan ideal for Wardrobes, Bathrooms, patios and balconies and small offices.

1400 mm. 1500 mm. 1600 mm.

Tech specs

Power: 68 watt 75 watt 90 watt
Airflow: 6500 CFM 7500 CFM 8000 CFM

Standard features

AC Motor
Fully compatible with Automation systems

Optional features

4 speed RF Remote control
Reversible operation (Summer / Winter)

Suitable mounting

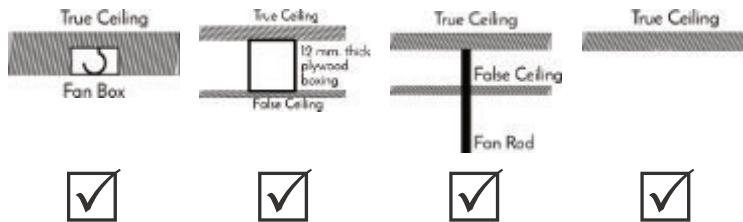

Dimensions



Matt pewter

56
INCH
1400 MM

Standard finish



Matt white

56
INCH
1400 MM

Standard finish



Matt black

56
INCH
1400 MM

Standard finish



Generation

Generation is a fan designed for Large spaces. Straight lines, elegant and pure sophistication.

Power house motor in a sleek package, designed to keep the largest of spaces cool with minimal air cutting sound.

The name of the fan gently reminds us of the generation ahead design.

900 mm. 1050 mm. 1200 mm. 1300 mm.

Tech specs

Power:	60 watt	70 watt	75 watt	75 watt
Airflow:	2500 CFM	4500 CFM	5900 CFM	6500 CFM

Standard features

AC Motor
Fully compatible with Automation systems

Optional features

4 speed RF Remote control

Suitable mounting

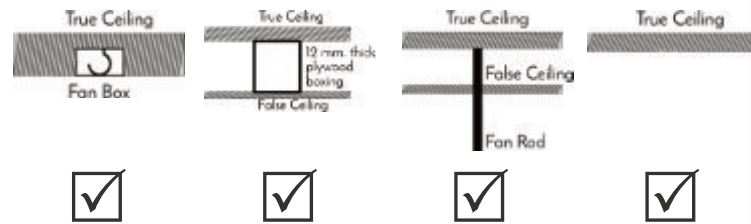

Dimensions



Antique bronze
Teak laminate wood
(Walnut matt)

48
INCH
1200 MM

Standard finish



Matt black
Teak laminate wood
(Walnut matt)

48
INCH
1200 MM

Standard finish



Heritage

1910

A fan which can be found in old cafe's and villas; Bold and Timeless.

A marvel of Design which was made in the 1910's now brought back to life, with the same spirit and Class.

Gentle breeze at Slow Speed and Strong wind at full speed - all this without making a sound. Handmade all Cast metal ceiling fan.

900 mm. 1050 mm. 1200 mm. 1300 mm.

Tech specs

Power: 60 watt 70 watt 75 watt 75 watt
 Airflow: 2500 CFM 4500 CFM 5900 CFM 6500 CFM

Standard features

AC Motor
 Fully compatible with Automation systems

Optional features

4 speed RF Remote control

Suitable mounting

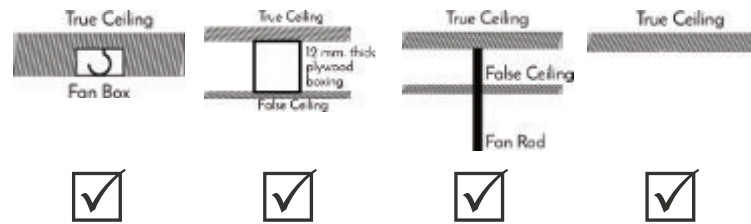

Dimensions





Heritage 1914

A fan which can be found in old cafe's and villas; Bold and Timeless.

A marvel of Design which was made in the 1910's now brought back to life, with the same spirit and Class.
Gentle breeze at Slow Speed and Strong wind at full speed - all this without making a sound.

Handmade all Cast metal ceiling fan.

900 mm. 1050 mm. 1200 mm. 1300 mm.

Tech specs

Power: 60 watt 70 watt 75 watt 75 watt
 Airflow: 2500 CFM 4500 CFM 5900 CFM 6500 CFM

Standard features

AC Motor
 Fully compatible with Automation systems

Optional features

4 speed RF Remote control

Suitable mounting

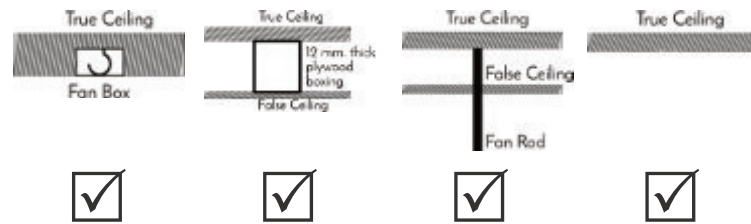

Dimensions



**Matt black
 Solid teak wood blades
 (Natural matt)**

48
 INCH
 1200 MM

Custom finish



**Matt black
 Solid teak wood blades
 (Walnut matt)**

48
 INCH
 1200 MM

Custom finish



Heritage

1925

A fan which can be found in old cafe's and villas; Bold and Timeless.

A marvel of Design which was made in the 1910's now brought back to life, with the same spirit and Class.

Body mounted hand-carved metal holders provide design flexibility and a classic fan look.

900 mm. 1050 mm. 1200 mm. 1300 mm.

Tech specs

Power: 60 watt 70 watt 75 watt 75 watt
 Airflow: 2500 CFM 4500 CFM 5900 CFM 6500 CFM

Standard features

AC Motor
 Fully compatible with Automation systems

Optional features

4 speed RF Remote control
 Reversible operation (Summer / Winter)

Suitable mounting

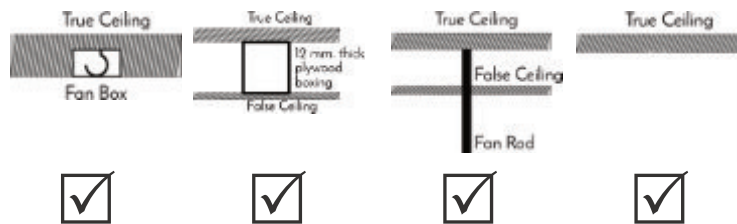

Dimensions



Matt pewter

48
 INCH
 1200 MM

Custom finish



Matt white

48
 INCH
 1200 MM

Custom finish



Hornet

HORNET is designed for an Industrial influenced modern look the visible holders and cooling slots give the design an Industrial edge.

Hidden inside is a powerful motor which churns the Air with ease.

1200 mm. 1400 mm.

Tech specs

Power: 62 watt 65 watt
Airflow: 6500 CFM 7600 CFM

Standard features

AC Motor
Fully compatible with Automation systems

Optional features

4 speed RF Remote control

Suitable mounting

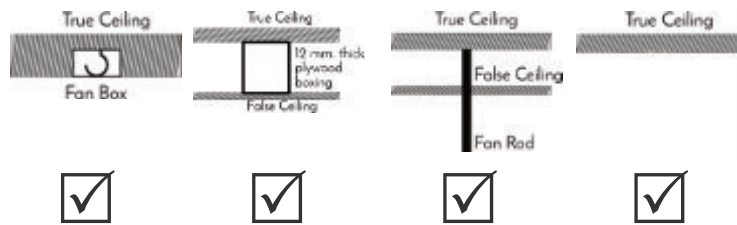

Dimensions



Matt pewter

56
INCH
1400 MM



Standard finish



Industrie

A contemporary and bold design with a very unique approach to fan design.

Capturing the essence of mechanical construction with exposed nuts & bolts, external wire carriers and unique edge cut blade design.

All this with industry standard air delivery performance and build quality.

1050 mm. 1200 mm. 1300 mm. 1400 mm.

Tech specs

Power :	60 watt	75 watt	80 watt	85 watt
Airflow :	3800 CFM	5000 CFM	5800 CFM	6900 CFM

Standard features

AC Motor
Fully compatible with Automation systems

Optional features

4 speed RF Remote control
Reversible operation (Summer / Winter)

Suitable mounting

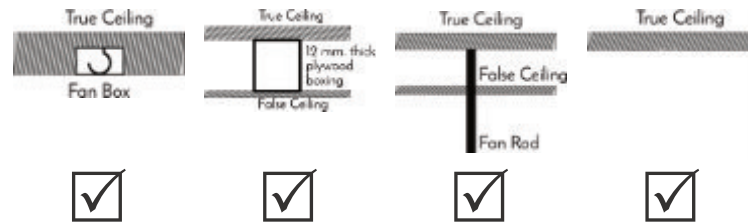

Dimensions



Matt white

52
INCH
1300 MM



Custom finish

Matt white
Wood finish Metal blades

52
INCH
1300 MM



Custom finish



Mareilly

Designed from “Flat” line collection of the pioneer Italian fan manufacturer Marelli.
Solid Cast body with liner lines, design influenced heavily from the Art Deco period.
This was the most sold fan design in the 1920’s with a few original pieces still in operation.

1200 mm. 1400 mm. 1500 mm. 1600 mm.

Tech specs

Power :	70 watt	80 watt	85 watt	85 watt
Airflow :	6500 CFM	7500 CFM	8200 CFM	8500 CFM

Standard features

AC Motor
Fully compatible with Automation systems

Optional features

4 speed RF Remote control
Reversible operation (Summer / Winter)

Suitable mounting

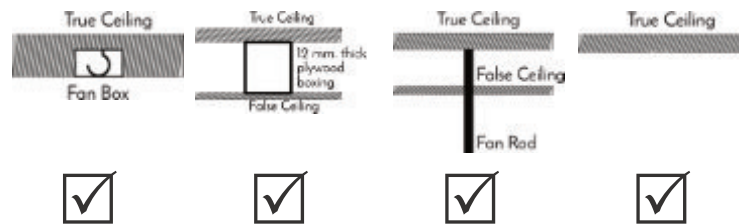

Dimensions



Matt black
Wood finish metal blades

56 INCH
1400 MM

60 INCH
1500 MM

Standard finish



Matt black

56 INCH
1400 MM

60 INCH
1500 MM

Standard finish



Matt white

56 INCH
1400 MM

60 INCH
1500 MM

Standard finish



Matt white
Wood finish metal blades

56 INCH
1400 MM

60 INCH
1500 MM

Standard finish



Modena

A fan designed for Large Spaces with minimal design elements, straight lines and organic shapes.

Light blades enable large sweep sizes and more Air volumes.

Die-Cast Aluminium construction with 18 Pole Super Heavy Duty Motor. Suitable for the most demanding and commercial applications.

1200 mm. 1400 mm. 1500 mm. 1600 mm.

Tech specs

Power: 70 watt 80 watt 85 watt 90 watt
Airflow: 6500 CFM 7500 CFM 8000 CFM 8500 CFM

Standard features

AC Motor
Fully compatible with Automation systems

Optional features

4 speed RF Remote control
Reversible operation (Summer / Winter)

Suitable mounting

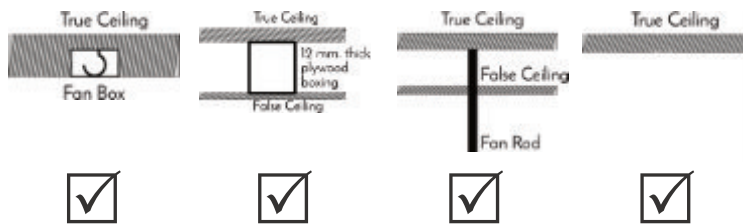

Dimensions



Glossy White
Jaipur Blue pottery bowl
(Blue fill)

56
INCH
1400 MM

Custom finish



Glossy White
Jaipur Blue pottery bowl
(Black fill)

56
INCH
1400 MM

Custom finish



Persia

The art of Blue Pottery is a culmination of Chinese glazing and Persian decorative arts, bought to India in 14th Century.

In 19th Century this art was bought to Jaipur by ruler Sawai Ram Singh II.

“Persia” pays tribute to this eye-catching traditional art of Jaipur by using it for the First time ever with a ceiling fan.

900 mm. 1050 mm. 1200 mm. 1300 mm.

Tech specs

Power: 60 watt 70 watt 75 watt 75 watt
Airflow: 2500 CFM 4500 CFM 5900 CFM 6500 CFM

Standard features

AC Motor
Fully compatible with Automation systems

Optional features

4 speed RF Remote control

Suitable mounting

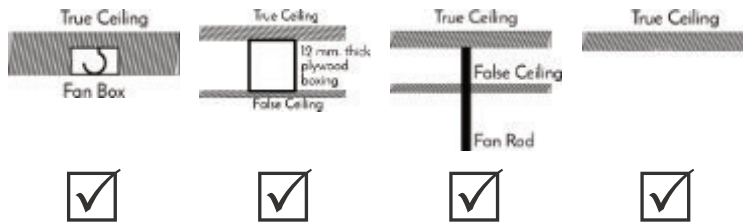

Dimensions

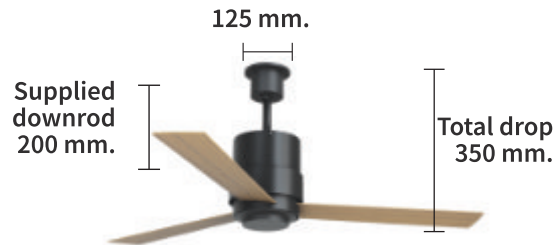

Brushed Aluminum Laminated Teak wood (Natural Matt finish)

48
INCH
1200 MM

Standard finish



Matt white

48
INCH
1200 MM

Standard finish



Rockefeller

Reminiscent of the Art Deco period, Rockefeller is a contemporary designed fan with distinct lines and edges.

By combining Aluminum and teak wood the fan design lends warmth to its surroundings.

High speed motor and flexibility of sweep options makes this fan ideal for all spaces.

1300 mm.

Tech specs

Power: 72 watt

Airflow: 8500 CFM

Standard features

AC Motor

Fully compatible with Automation systems

Optional features

4 speed RF Remote control

Reversible operation (Summer / Winter)

Suitable mounting

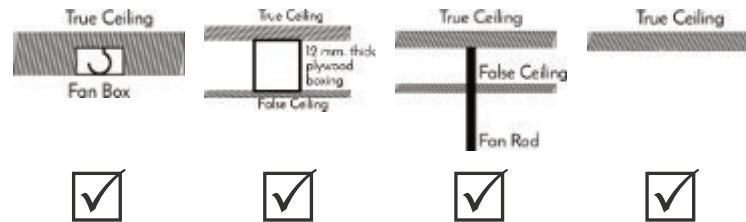

Dimensions

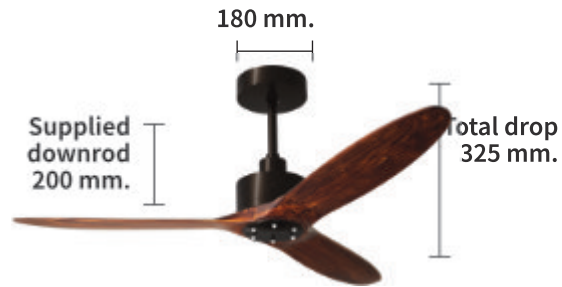

Brushed Aluminum + Solid wood propellers (Dark Matt finish)

52
INCH
1300 MM

Standard finish



Oil Rubbed Bronze + Solid wood propellers (Dark Matt finish)

52
INCH
1300 MM

Standard finish

Main display picture finish

Polished Aluminum + Solid wood propellers (Dark Matt finish)

52
INCH
1300 MM

Custom finish



Sabre

A finely designed ceiling fan that is a work of art in its own right. A high-speed fan with great air delivery. Sabre comes with Carved wood propeller blades that look like airplane wings providing an alternative spin on this modern design piece. Handcrafted and hand-polished in premium solid wood dark matt finish

1050 mm. 1200 mm. 1300 mm.

Tech specs

Power: 60 watt 65 watt 75 watt
Airflow: 3800 CFM 5000 CFM 5800 CFM

Standard features

AC Motor
Fully compatible with Automation systems

Optional features

4 speed RF Remote control
Reversible operation (Summer / Winter)

Suitable mounting

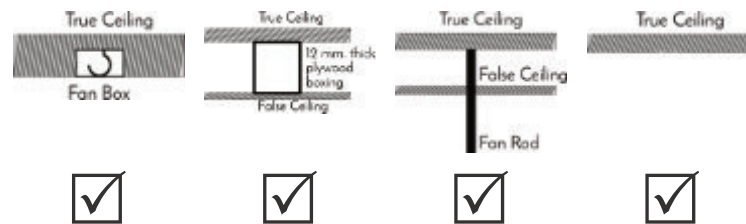

Dimensions



**Matt pewter
Solid teak wood blades
(Walnut matt finish)**

52
INCH
1300 MM

Standard finish



**Matt white
Solid teak wood blades
(Walnut matt finish)**

52
INCH
1300 MM

Standard finish

Main display picture finish

**Matt black +
Matt black Aluminum blades**

52
INCH
1300 MM

Custom finish



Sceptre

Super efficient 7 blade design, inspired from Turbines blades; churning out large volumes of air in a compact size.

Suitable for commercial, hospitality and residential applications. Ideal for dining, meeting or living rooms.

1300 mm. 1400 mm. 1800 mm.

Tech specs

Power: 67 watt 75 watt 90 watt
Airflow: 8600 CFM 9500 CFM 10000 CFM

Standard features

AC Motor
Fully compatible with Automation systems

Optional features

4 speed RF Remote control
Reversible operation (Summer / Winter)

Suitable mounting

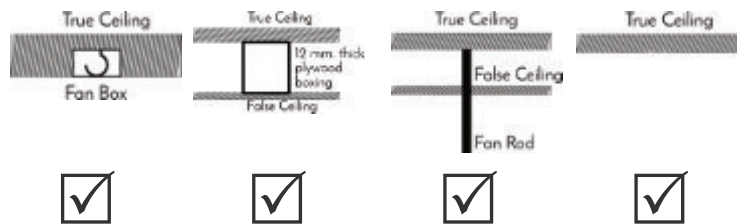

Dimensions



**Matt black
Layered Birchwood propellers
(Dark Walnut matt)**

52
INCH
1300 MM

Standard finish



Spitfire

Named from a World War II fighter plane, the propellers are Hand-Carved from a solid piece of Wood.

Symmetrically designed motor, aesthetically elegant yet powerful enough to generate a storm.

1300 mm. 1400 mm. 1800 mm.

Tech specs

Power: 67 watt 75 watt 90 watt
Airflow: 8600 CFM 9500 CFM 10000 CFM

Standard features

AC Motor
Fully compatible with Automation systems

Optional features

4 speed RF remote control

Suitable mounting

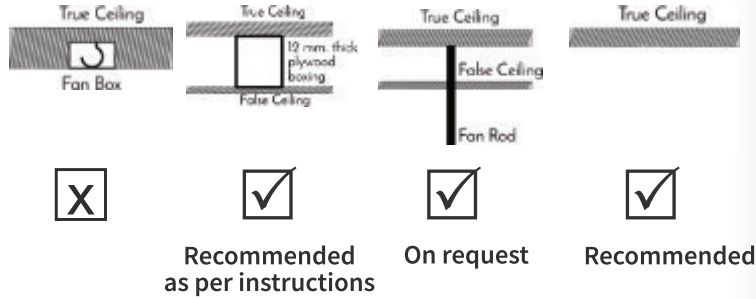

Dimensions



Matt Black Layered Birchwood propellers (walnut matt)

52 INCH 1300 MM

Standard finish



Matt White Layered Birchwood propellers (Walnut matt finish)

52 INCH 1300 MM

Custom finish



Matt Pewter Layered Birchwood propellers (Walnut matt finish)

52 INCH 1300 MM

Custom finish



Spitfire hugger

HUGGER (Flush Ceiling Mounting) designed to install ceiling fan for Low Height ceilings, without compromise on air delivery.

Named from a World War II fighter plane, the propellers are Hand-Carved from a solid piece of Wood.

Symmetrically designed motor, aesthetically elegant yet powerful enough to generate a storm.

1800 mm. 2100 mm.

Tech specs

Power : 140 watt 150 watt
Airflow : 10000 CFM 14600 CFM

Standard features

AC Motor
Fully compatible with Automation systems
4 speed RF Remote control

Suitable mounting

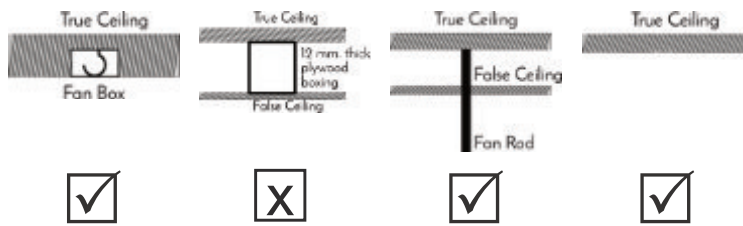

Dimensions

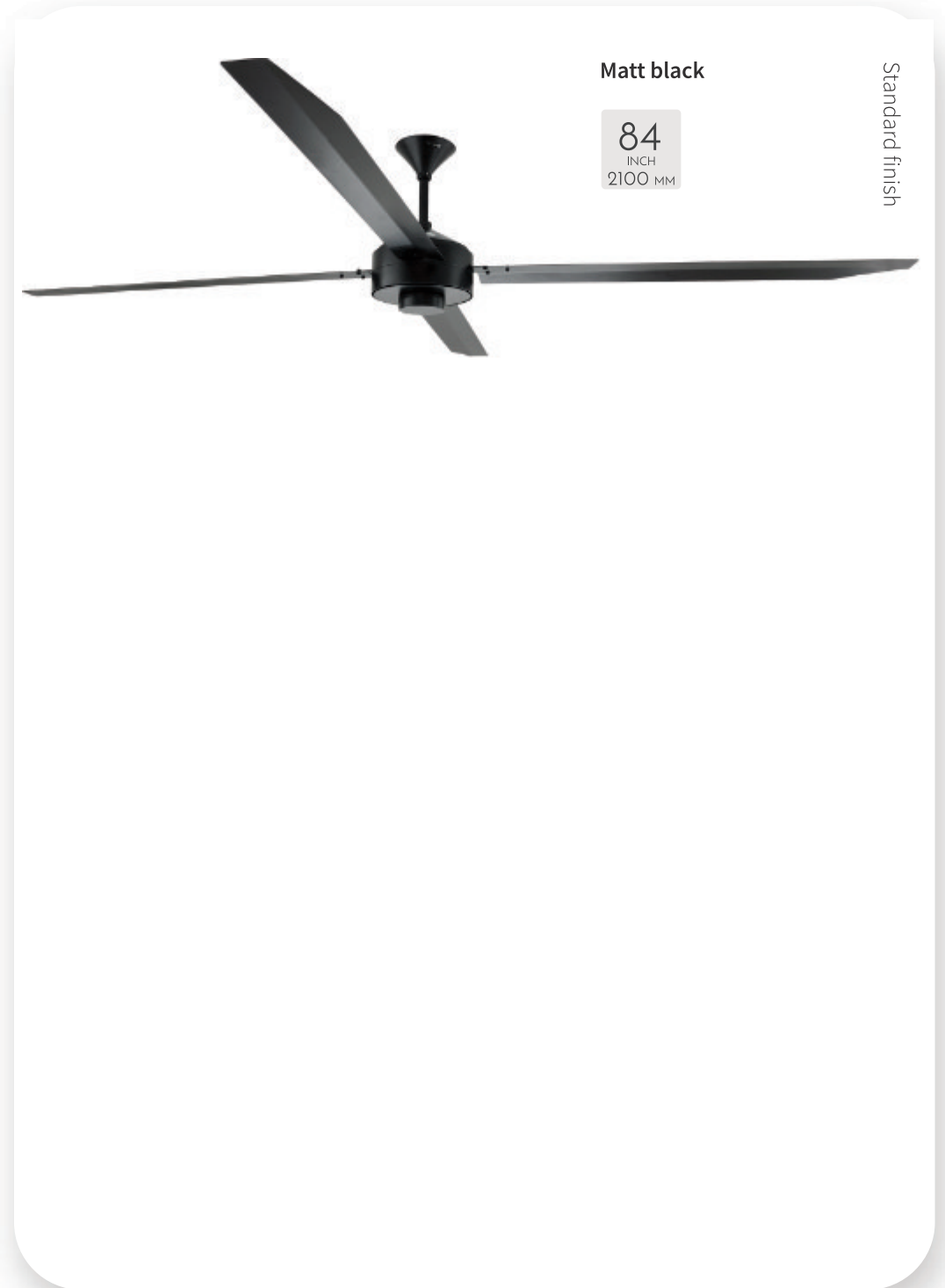
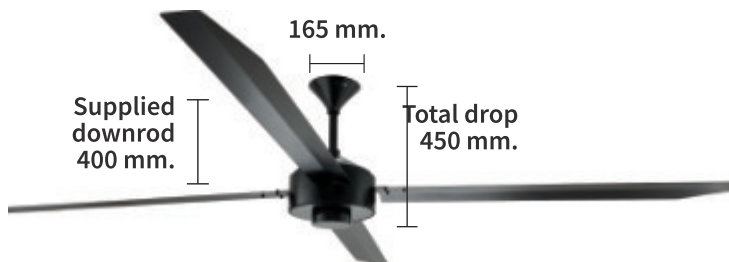



Stark

Stark is the most powerful fan Windmill has to offer.

It can be used to cool Restaurants, Hotel lobbies, Lounge spaces,
Retail showrooms, Commercial spaces and Residential spaces.

Modern design with light industrial elements; all of which can be customised to suit any project.

1200 mm.

Tech specs

Power : 65 watt

Airflow : 6500 CFM

Standard features

AC Motor

Fully compatible with Automation systems

Optional features

4 speed RF Remote control

Reversible operation (Summer / Winter)

Suitable mounting

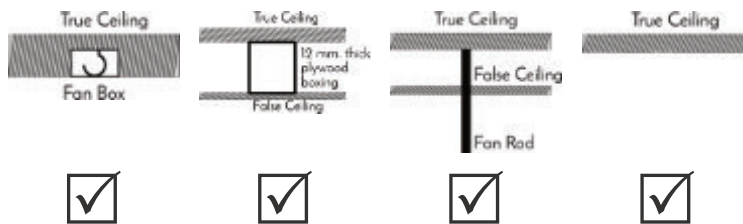

Dimensions



Matt white

48
INCH
1200 MM

Standard finish



Matt black

48
INCH
1200 MM

Standard finish



Stealth

A look inspired from a Stealth aircraft; sharp bends and straight lines.

Energy saving AC technology brings about the best in performance and efficiency in a fan.

Wide air spread pattern with smooth air movement in low speeds makes this ideal for offices, bedrooms and work spaces.

1200 mm.

Tech specs

Power: 70 watt

Airflow: 6500 CFM

Standard features

AC Motor

Fully compatible with Automation systems

Optional features

4 speed RF remote control

Suitable mounting

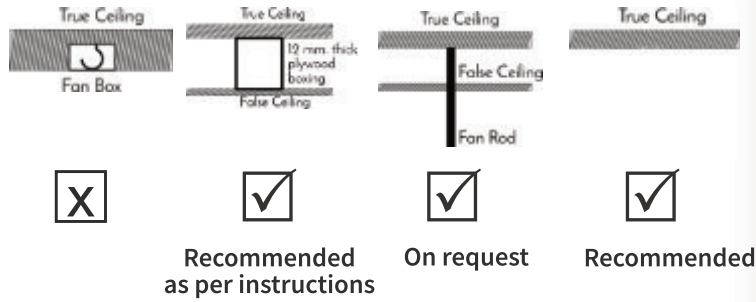

Dimensions



Matt white

48
INCH
1200 MM



Standard finish

Matt black

48
INCH
1200 MM



Standard finish

Matt pewter

48
INCH
1200 MM



Custom finish



Stealth hugger

HUGGER (Flush Ceiling Mounting) designed to install ceiling fan for Low Height ceilings, without compromise on air delivery.

A look inspired from a Stealth aircraft; sharp bends and straight lines.

AC technology brings about the best in performance with complete Automation compatibility.

400 mm.

Tech specs

Power: 73 watt

Airflow: 1800 CFM

Standard features

AC Motor

Fully compatible with Automation systems

Dimensions

Total fan height
400 mm. Sweep - 1275 mm.



**Antique Bronze
Solid wood legs
(Walnut Matt finish)**

16
INCH
400 MM

Standard finish



Classico

The all Handmade Solid wood pedestal fan.
Classic design is bound to bring charm and warmth to any room,
office or library decor.
Functional design with Oscillation and 3 Speed selector.

1400 mm.

Tech specs

Power: 70 watt

Airflow: 6500 CFM

Standard features

AC Motor

Fully compatible with Automation systems

3 speed controller

Suitable mounting

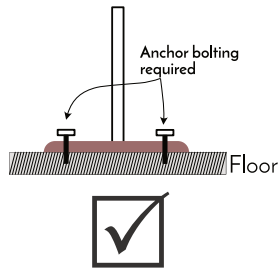

Dimensions

Total fan height

2500 mm.



IP60

Indoor rated



Antique Bronze

56
INCH
1400 MM

Standard finish

Riviera can be seen in Grand Ballrooms with high ceilings, cozy patios & sunny decks.

Curved blades elegantly spread the cool air down as the fan whirls in silence.

All metal powder painted parts, ensures the fan stands the harsh heat, cold and damp winds.



Riviera

IP60

Indoor rated

1400 mm.

Tech specs

Power: 70 watt

Airflow: 7800 CFM

Standard features

AC Motor

5 speed wall controller 

Fully compatible with Automation systems

Suitable mounting

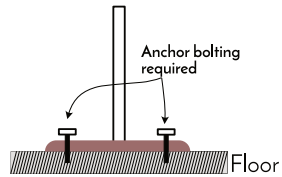

Dimensions

Total fan height

2500 mm.

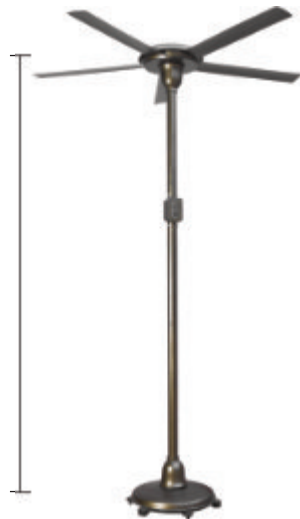

IP64

Outdoor wet rated



Antique Bronze

56
INCH
1400 MM

Standard finish

Riviera Mark 2 features Rain protection. So you can install the fan in open spaces and be free of mind that rain can do any harm.

Curved blades elegantly spread the cool air down as the fan whirls in silence.

All metal powder painted parts, ensures the fan stands the harsh heat, cold and damp winds.



Riviera mark 2

IP64

Outdoor wet rated

300 mm. 400 mm.

Tech specs

Power: 40 watt 73 watt

Airflow: 1200 CFM 1800 CFM

Standard features

AC Motor

Fully compatible with Automation systems

Dimensions

Total fan height

300 mm. Sweep - 1200 mm.

400 mm. Sweep - 1275 mm.

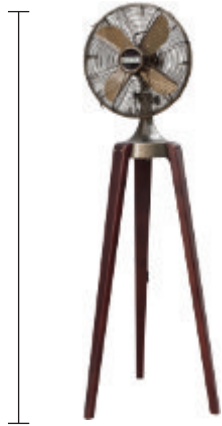

**Matt pewter
Solid wood legs
(Natural Matt finish)**

12
INCH
300 MM

16
INCH
400 MM

Standard finish



**Antique Bronze
Solid wood legs
(Walnut Matt finish)**

12
INCH
300 MM

16
INCH
400 MM

Standard finish



Tripod

Handmade all metal Rugged and Durable fans; Classic TRIPOD design with hand polished Solid wood legs.

A true symbol of Luxury for your office, lounge or Study.

Oscillating design with Great air delivery and built-in 3 Speed controller.





SPITFIRE



INDUSTRIE



COLONIA

GALLERY



COLONIAL CABIN



ASANA



SCEPTRE



BAROLLO



GENERATION



ASANA HUGGER



SCEPTRE

GALLERY



AIRXONE



ASANA



COLONIA



GENERATION



MODENA



AMALFI



AIRXONE

GALLERY

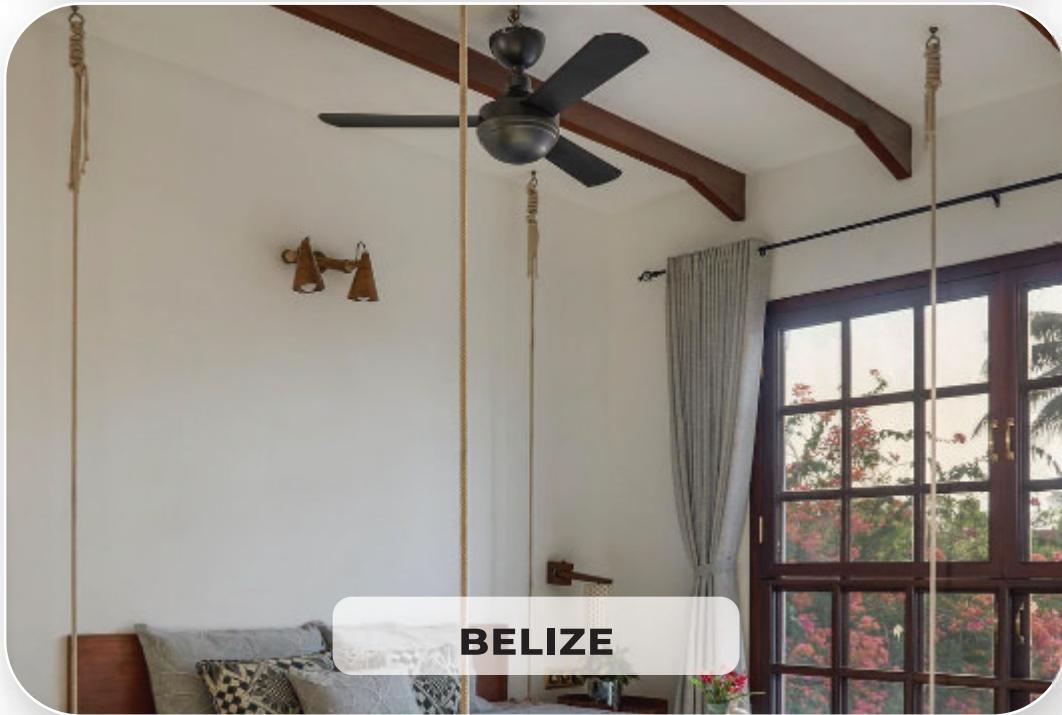



HORNET



AIRNAUTIK



BAROLLO CEILING

GALLERY

OUTDOOR GRADE



Matt Pewter (MP)



Matt Black (MB)



Matt White (MW)

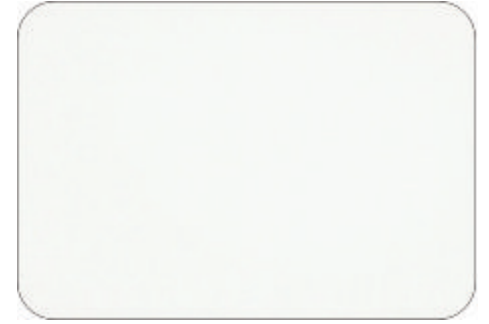

Glossy White (GW)

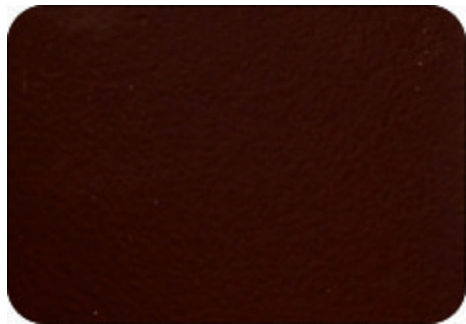

Oil Rubbed Bronze (ORB)



Matt Copper (MC)



Antique White (AW)

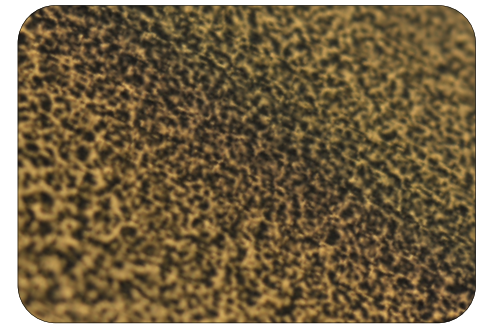

Antique Bronze (AB)

INDOOR GRADE



Gold (G)



Polished Aluminium (PA)



Brushed Aluminium (BA)



Glossy Copper (GC)

INDOOR GRADE



Brushed Brass (BB)

OUTDOOR GRADE WOOD FINISH

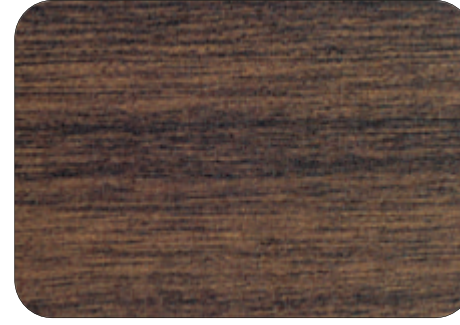

Wood Finish metal blades (WFM)

WOOD FAN BLADES AND FINISH



Teak plywood blades (LTW-W)
Dark Matt finish

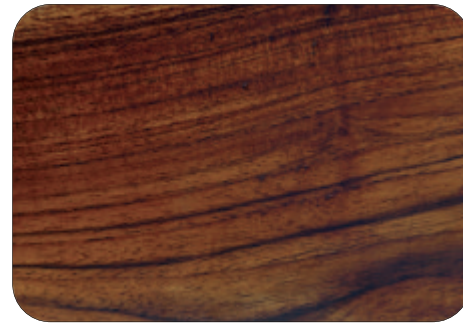

Solid Teak wood (STW-W)
Dark Matt finish



Beech Wood (BW)
Natural Matt finish



Teak plywood blades (LTW-N)
Natural Matt finish



Solid Teak wood (STW-N)
Natural Matt finish

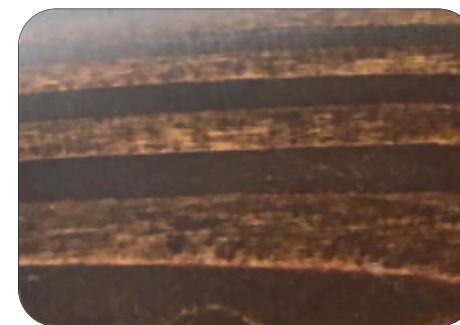

Birch Wood propeller (BIRWP)
Dark Matt finish

CUSTOM FAN FINISHES

AIRNAUTIK



Sweep size (cm.)

90 130
105
120

Optional accessories

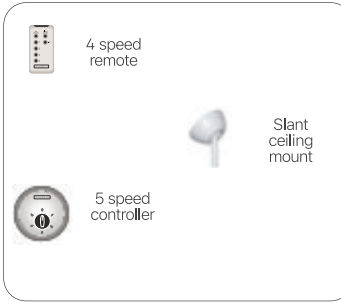

Motor & blade finish

Wood blade finish

AIRXONE



90 130
105
120

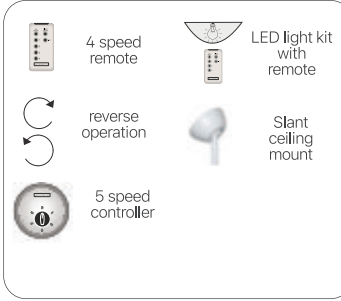

Motor & blade finish

Wood blade finish

AIRXONE HUGGER



90 130
105
120

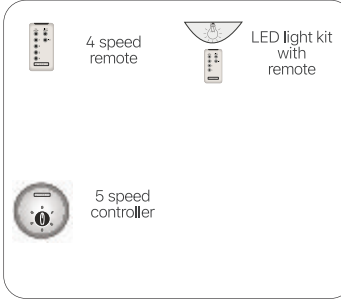

Motor & blade finish

Wood blade finish

AMALFI



90 130
105
120

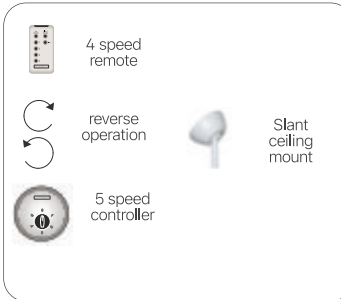

Motor & blade finish

Wood blade finish

AMANTE



Sweep size (cm.)

105
117

Optional accessories

- 4 speed remote
- reverse operation
- 5 speed controller
- Slant ceiling mount

		MC	AB	MP	ORB
MB	MW	GW		BB	
BIRWP					

Motor & blade finish

Wood blade finish

ANTONOV



Sweep size (cm.)

130
140

Optional accessories

- 4 speed remote
- 5 speed controller
- Slant ceiling mount

		MC	AB	MP	ORB
MB	MW	GW		BB	PA
BIRWP			BCW-N		

Motor & blade finish

Wood blade finish

ASANA



Sweep size (cm.)

90 **130**
105 **140**
120 **150**

Optional accessories

- 4 speed remote
- reverse operation
- 5 speed controller
- Slant ceiling mount

GC	GOLD	MC	AB	MP	ORB
MB	MW	GW	BA	BB	
STW-M	STW-N	LTW-W	LTW-N		WMB

Motor & blade finish

Wood blade finish

ASANA HUGGER



Sweep size (cm.)

90 **130**
105 **140**
120 **150**

Optional accessories

- 4 speed remote
- 5 speed controller

GC	GOLD	MC	AB	MP	ORB
MB	MW	GW	BA	BB	
STW-M	STW-N	LTW-W	LTW-N		WMB

Motor & blade finish

Wood blade finish

ASANA
NEO



Sweep size (cm.)

120
130
140

Optional accessories

- 4 speed remote
- reverse operation
- 5 speed controller
- Slant ceiling mount

GC	GOLD	MC	AB	MP	ORB	Motor & blade finish
MB	MW	GW	BA	BB		
					WMB	Wood blade finish

BAROLLO
CEILING



40
45
55

Optional accessories

- 4 speed remote

			MC	AB	MP	ORB	Motor & blade finish
MB	MW	GW					
STW-M	STW-N	LTW-W	LTW-N	BCW-N			Wood blade finish

BAROLLO
LEAF



40
45
55

Optional accessories

- 4 speed remote

			MC	AB	MP	ORB	Motor & blade finish
MB	MW	GW					
			LTW-W	LTW-N			Wood blade finish

BAROLLO
WALL



40
45
55

Optional accessories

- 4 speed remote

			MC	AB	MP	ORB	Motor & blade finish
MB	MW	GW					
STW-M	STW-N	LTW-W	LTW-N	BCW-N			Wood blade finish

Sweep size (cm.)

Optional accessories

BELIZE



105 140
120
130

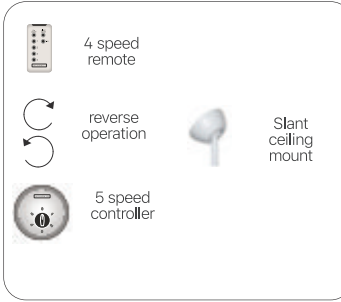

Motor & blade finish

Wood blade finish

BIJOU



60
90

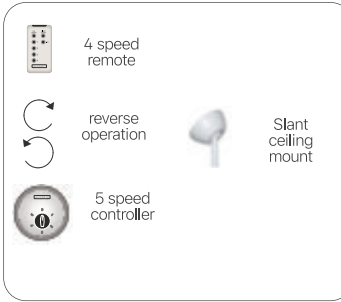

Motor & blade finish

Wood blade finish

BIJOU HUGGER



60
90

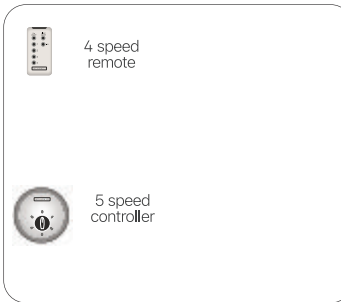

Motor & blade finish

Wood blade finish

COLONIAL



105 140
120
130

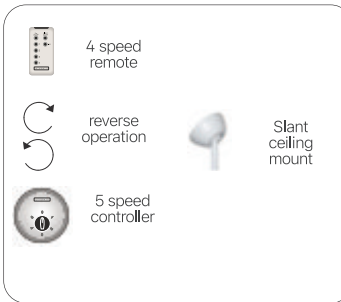

Motor & blade finish

Wood blade finish

CABIN



Sweep size (cm.)

30
40

Optional accessories



5 speed controller

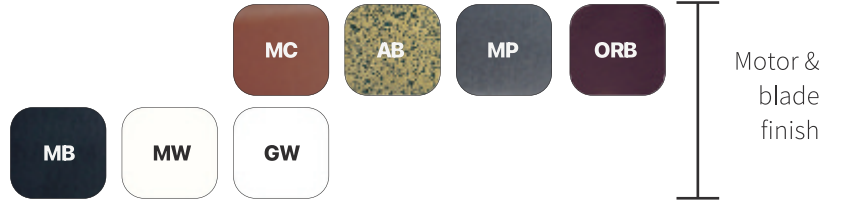

CLASSICO



30
40



CURTISS



130

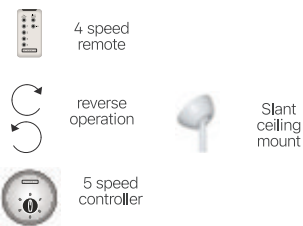

CUSTISS JR.



60
90

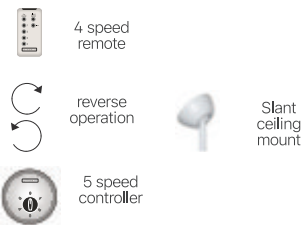

GENERATION



Sweep size (cm.)

140
150
160

Optional accessories

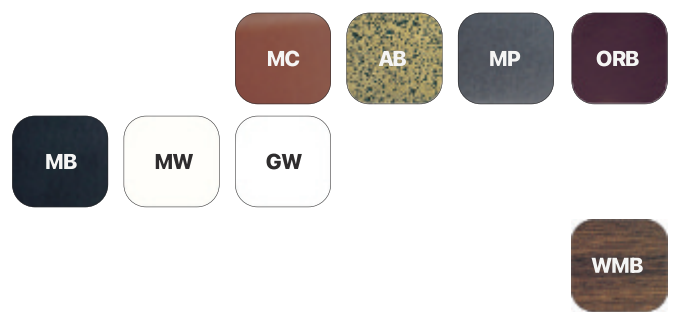
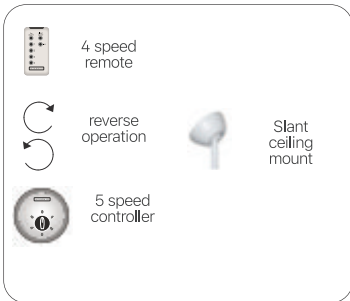

Motor & blade finish

Wood blade finish

HERITAGE 1910



90 130
105
120

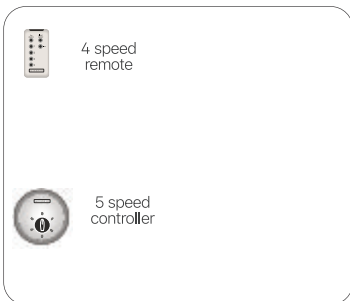

Motor & blade finish

Wood blade finish

HERITAGE 1914



90 130
105
120

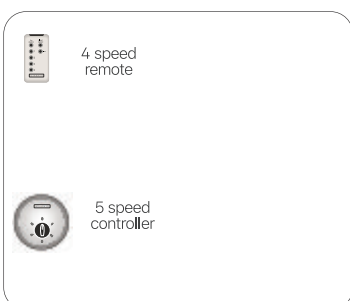

Motor & blade finish

Wood blade finish

HERITAGE 1925



90 130
105
120

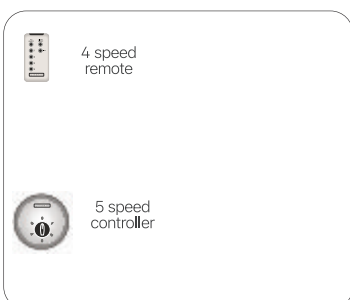

Motor & blade finish

Wood blade finish

HORNET



Sweep size (cm.)

90 130
105
120

Optional accessories

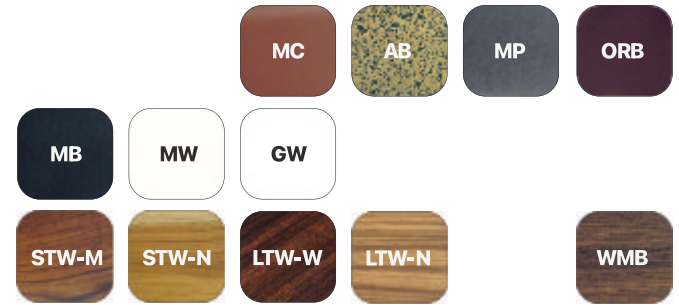
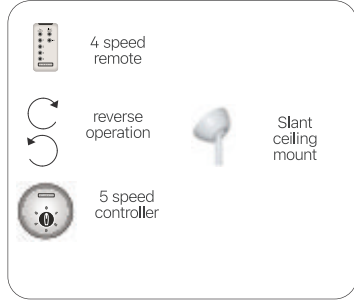

Motor & blade finish

Wood blade finish

INDUSTRIE



120
140
150

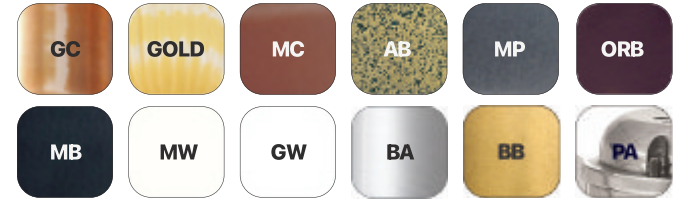
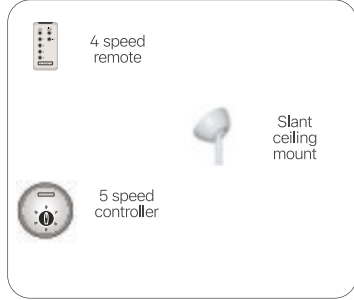

Motor & blade finish

MAREILLY



105 140
120
130

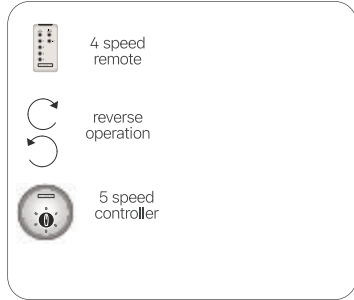

Motor & blade finish

Wood blade finish

MODENA



120 160
140 170
150

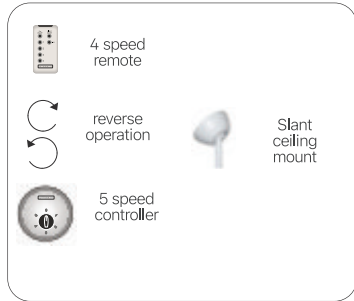

Motor & blade finish

Wood blade finish

PERSIA



Sweep size (cm.)

120 150
130
140

Optional accessories

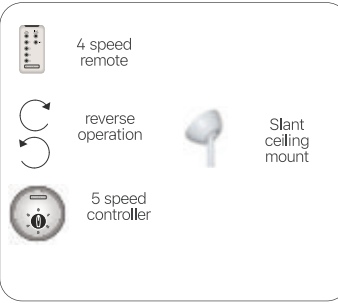

Motor & blade finish

ROCKEFELLER



90 130
105
120

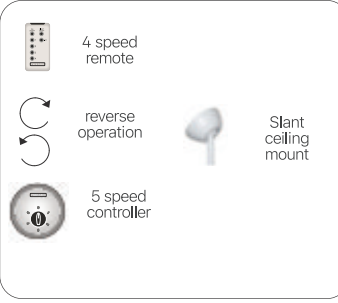

Motor & blade finish

Wood blade finish

RIVIERA MARK 2



150
160

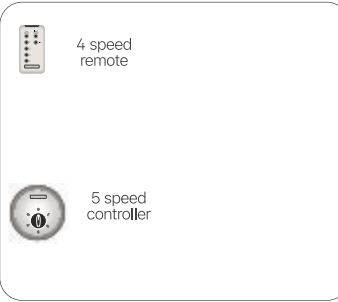

Motor & blade finish

Wood blade finish

RIVIERA



140
150

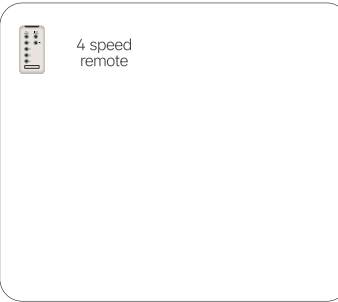

Motor & blade finish

Wood blade finish

SABRE



Sweep size (cm.)

130

Optional accessories

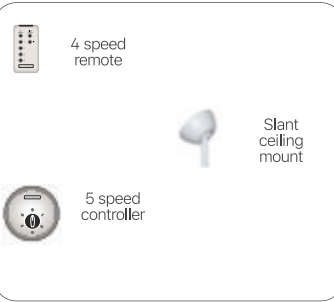

Motor & blade finish

SCEPTRE



105
120
130

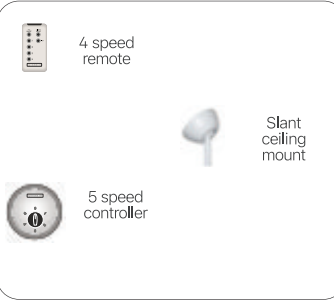

Motor & blade finish

Wood blade finish

SPITFIRE



130
140

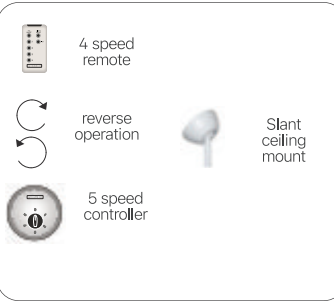

Motor & blade finish

Wood blade finish

SPITFIRE HUGGER



130
140

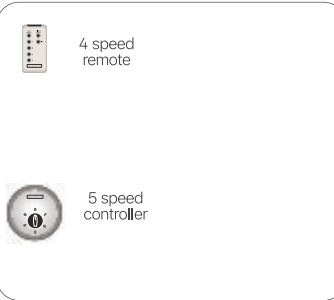

Motor & blade finish

Wood blade finish

STARK



Sweep size (cm.)

180
210

Optional accessories

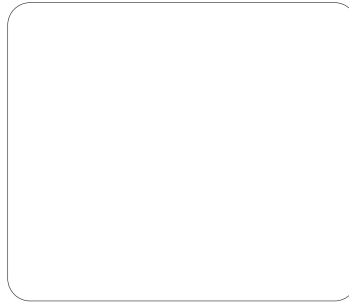

Motor & blade finish

Wood blade finish

STEALTH



130

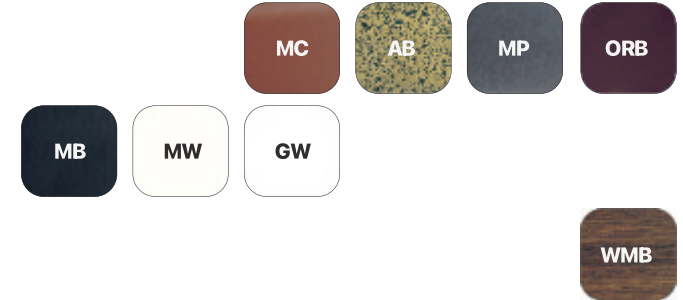
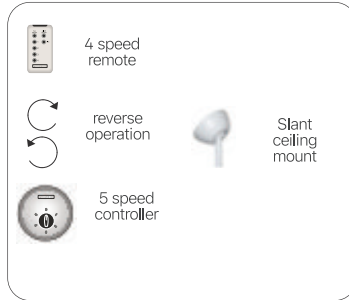

Motor & blade finish

Wood blade finish

STEALTH HUGGER



130

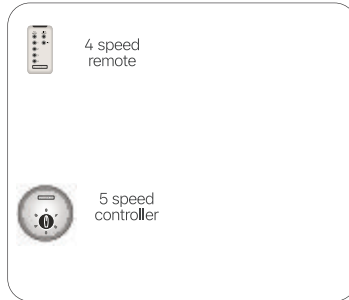

Motor & blade finish

Wood blade finish

TRIPOD



30
40

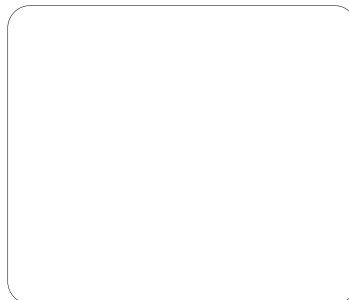

Motor & blade finish

Pedestal Leg finish

Disclaimer

Above displayed shades are for visual reference and do not show the actual shade of the product. For accurate colour and texture please refer to physical swatches available with our dealers. You can also write to us to order a physical swatch booklet.

Since 1980's these fans have been exported to Europe, United Kingdom, Australia and USA. They have gathered accolades from Designers, Architects and have earned the trust of millions of discerning clients.

We have undertaken projects with size ranging from One home to 300 home residential projects, from boutique hotels to 200 room 5 Star Spa and Resort.

No Customer is small for us; we can supply quantities as small as 2 fans to as large as container loads.

Few of our esteemed clients include the following

KHOSLA ASSOCIATES
ARCHITECTURE+
INTERIOR DESIGN

HUNDREDHANDS

SANGATH

MANOINI

AUM
ARCHITECTS

pencil & monkTM

RESEARCH
DESIGN
OFFICE
A Member of the Workshop Group

**WOODS
AT
SASAN**

COLLABORATIVE
ARCHITECTURE



_opolis architect

ASHIESH SHAH
ARCHITECT

chiraag
kapoor

ARCHITECTS

Studio LAB

FACILIS
creativity with zero opacity



Arvind varuna associates

K2 INDIA
SUNITA KOHLI | KOHELIKA KOHLI

S+PS
architects

sP+a

SONA
REDDY
STUDIO

OUR
CLIENTS

morphogenesis

Transform

studio 2+2

asds
Aditi Sharma
Design Studio

INTERSPACE 

CONTRACT & COMMERCIAL DESIGN **C**

SNA
Sidharth Narayan
Associates

Designers Circle
(Ahmedabad)

Ar. Manpreet Singh
(Delhi)

Ar. Sudeep Verma
(Delhi)

Int. Suchitra Singh
(Kanpur)

Hotel Shompen
(Chennai)

Century Builders
(Bangalore)

InHaus Design
(Hyderabad)

Nattika Beach Resort
(Kovalam)

Laxmi Machine Works Intas Pharmaceuticals

ZANNIER HOTELS
Bãi San Hô
(Vietnam)



DE FORET
DISCOVER NATURE
(Andamans)

HRH Group of Hotels
(Udaipur)

The earth
(Amritsar)

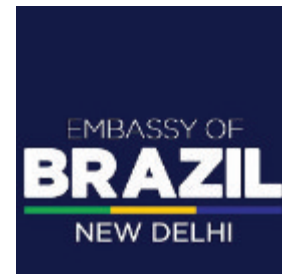

OUR CLIENTS





SHOWROOM
PARTNERS



PDF
BROCHURE



EMAIL
YOUR QUERY

WWW.WINDMILLFANS.COM

U. P. NATIONAL MANUFACTURERS LTD.
C 26/34 -B-D, SHREE DHAM COMPLEX,
RAMKATORA ROAD, VARANASI - 221002. U.P. (INDIA)