



LÜFT®

QUALITY IS NOT EXPENSIVE IT'S PRICELESS

# *Catalogue*

2023-2024 (1st Quarter)





## HOW TO FIND THE **PERFECT FAN**

### IF MY ROOM SIZE IS...

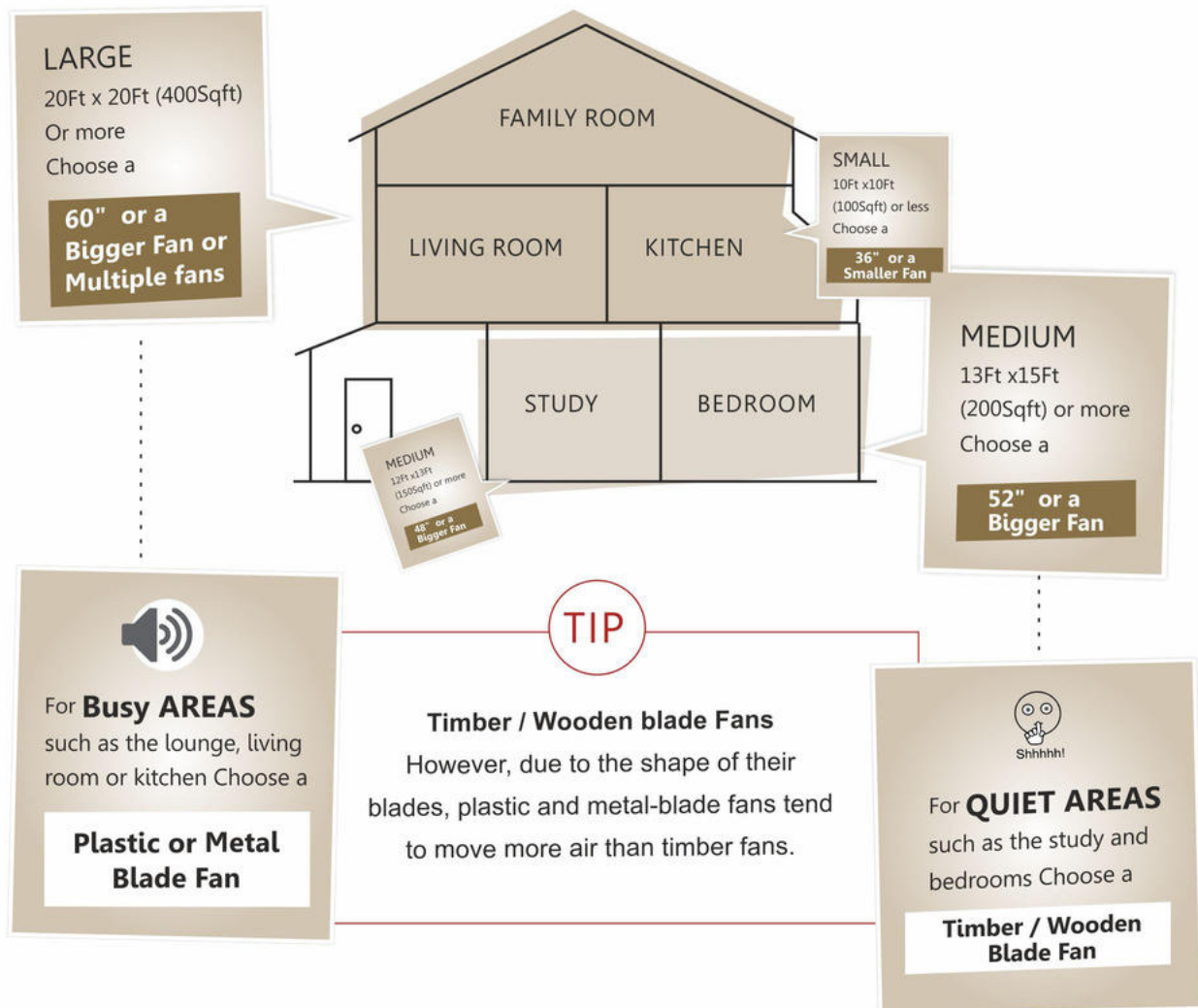

### WHAT IF MY ROOM HAS A HIGH CEILING?

If your ceiling height is 10Ft or more you may require:  
Extension rod (You are in luck as almost all Luft fans come with an optional extension rod)

Fan should be installed at least 12" from the ceiling with at least 7.5Ft from the blades to the floor.

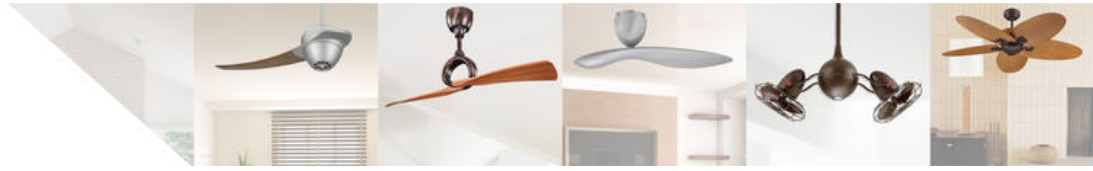

# Contents

**INTRODUCTION**

**OUR BRANDS**

**CEILING FAN INSTALLATION GUIDE**

**TROUBLE SHOOTING**

**CEILING FAN INSTALLATION SERVICE**

**WARRANTY TERMS**

**VISUAL INDEX**

**VISUAL INDEX R2R**

**CURTAIN MOTOR**

**LÜFT CREATE**

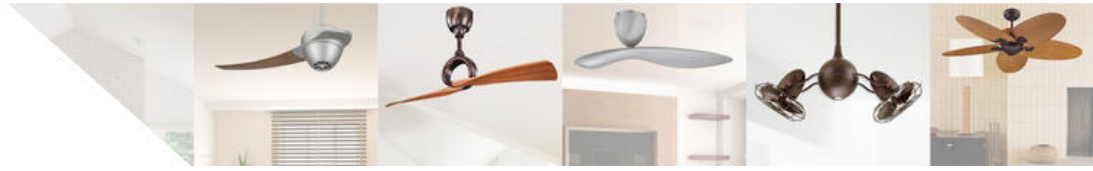

## IT TAKES WISDOM TO EXPLORE THE WAY AND COURAGE TO MAKE A CHANGE.

### LUFT was created with an inherent intent to 'break the stereotype' when it comes to home décor.

A carefully chosen fan creates an impact on your environment that alters and elevates your mood while also elevating the look of your home. After all, your personal environment is what contributes to your overall well-being, bringing your best version to the forefront.

Backed by science, and powered by the latest in technology, LUFT has grown to become a leader in Fans and Curtain Motor industry.

As a company, we pride ourselves on the quality and workmanship of every product we produce & distribute. With people and a distribution network operating over two continents, LUFT is leading the way in product design, along with three levels of quality control over a broad range of price points. To specify, we fill in every space and meet your unique needs that fit your budget.

LUFT offers the following products to enhance the 'Class Quotient' of your home:

#### LUFT FANS:

LUFT believes that the fifth wall is as important as the other four walls of the house, to create an aesthetically pleasing home. We bring you the largest range of exquisite designer fans in India, which breaks the monotony and raises the décor of your home which echoes elegance and comfort. Most importantly, they are manufactured in so many sizes to fit in any given space.

Our special emphasis on robust product quality ensures that the sheer beauty of LUFT Fans never fades. Our collection includes genuine, high quality and competitively priced **Exquisite Fans** from topmost international players. What sets us apart is our '**service excellence**', which is an integral part of our value system, making your LUFT experience, hassle-free. To ensure your peace of mind, all LUFT fans come with a two-year warranty.

The prime focus of LUFT is introducing fans from across the globe that circulate air using the latest technology for efficiency and convenience, with a seamless control and premium design that's stellar. Our fans cover all requirements for homes, including decorative styles to slim designs, traditional designs to modern masterpieces that blend effortlessly into any interior. The options that we have will make you smile as you get to choose from different sizes, and designs, fitting into different spaces - ranging from the ceiling, floor fans & wall mounted to tower fans.

Our national network has helped our fans find a presence in diverse areas - from some of the most luxurious places like resorts and palaces to the intimate and personal spaces in homes and commercial establishments around INDIA. That's huge and we take immense pride in bringing you comfort wherever you go.

#### LUFT MOTORS:

Your home is priceless artwork for you and we at Luft acknowledge it. We believe that normal is boring. Conventional curtains have a limited role to play in your home aesthetics. LUFT offers ultra-efficient and ultra-quiet motorized systems for all kinds of curtains and blinds. LUFT motors come in various specifications to suit any commercial or domestic needs.

The product line consists of:

- Roller Blind Motors
- Remote Control Handsets

All our motors can be controlled either with remote control or can also be integrated with any home automation solution. Quality and winning your trust matter the most to us and hence LUFT motors come with **5 years warranty**.

**OUR VISION:** To be the leading National and International provider of innovative, technologically advanced, and energy-efficient products that enhance our customer's environments.

**OUR MISSION:** To light our customers' lives with exciting products that are environment-friendly and fashionable, delivered with expertise and unparalleled service.

#### OUR VALUES

- Be Innovative
- Be Caring
- Be Ethical

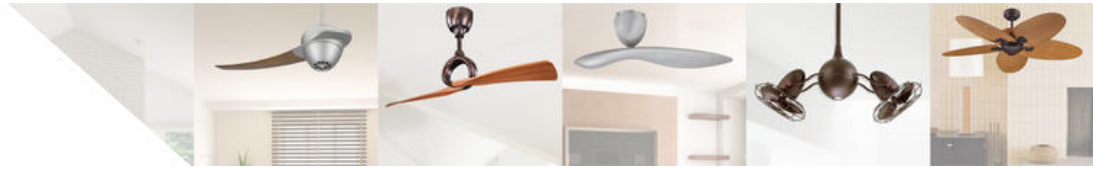

Fanaway is a revolutionary Australian design that has taken the world by storm. With one flick of the switch, Fanaway transforms from a sleek sophisticated, pendant light into an energy efficient ceiling fan. The secret lies in Fanaway's unique retractable blade technology. Turning the fan on creates a centrifugal force which deploys the distinctive blades to circulate air within a room. Switch it off, and the fan blades automatically retract and conceal, creating a clutter-free overhead environment.

#### Awards

- Home Beautiful Product of the Year Awards 2008, Finalist
- Best Homewares & Kitchen Product or Range, Finalist - Home/Lifestyle, The Gift Awards 2008
- Most innovative Product or Service, Finalist - Conscience & Creativity, The Gift Awards 2008
- Best Homewares & Kitchen Product or Range, Finalist-Australian Designed and/or Manufactured,
- The Gift Awards 2008

## LUCCI AIR

Lucci air is well known for it's great quality, with a heavy focus on technology and product development.

The Lucci brand offers the latest on-trend designs, sourced from around the globe, to suit every style of home.

The range offers great value with options for every budget.



The Bayside fan range has been developed to be simple in design with a focus on energy efficiency.

Constructed from high quality materials, Bayside fans are suitable for both indoor and outdoor applications.

LUFT has grown to become a leader in the Fans, Coatings and Motor industry.

As a company, we pride ourselves on the quality and workmanship of each and every product we produce & distribute.

With people and distribution network operating on two continents, LUFT is leading the way in product design, along with three level of quality control over a broad range of price points.

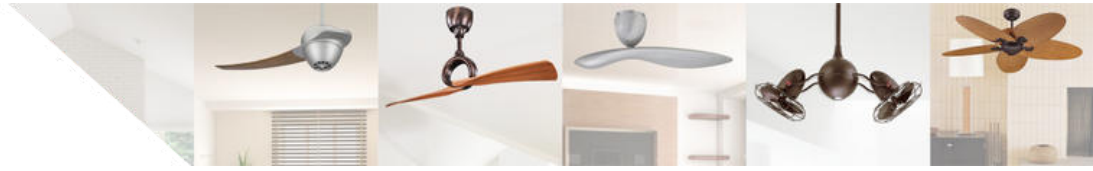

# STEP BY STEP CEILING FAN INSTALLATION GUIDE

## Installation Safety Rules

- ⚠ Shut the power off at the circuit breaker box before beginning.
- ⚠ Verify there are no obstructions at the installation site.
- ⚠ Use only clamps / rods & hooks which come with the fan.
- ⚠ Read the manufacturer's instructions for additional caution, safety, & warning information.

## Recommended Tools for Installing a Ceiling Fan

- |                                 |                       |
|---------------------------------|-----------------------|
| 1. Crescent Wrench              | 6. Screwdrivers       |
| 2. Cordless Drill with Long Bit | 7. Electrician's Tape |
| 3. Voltage Tester               | 8. Ladder             |
| 4. Wire Cutters/Strippers       | 9. Dusk Mask          |
| 5. Pliers                       | 10. Safety Glasses    |

## Where to hang a Ceiling Fan

Choosing an installation site is as important as selecting the ceiling fan itself. The right location ensures your safety as well as the fan's performance and efficiency. When selecting an installation site, consider the following details:

Always install a ceiling fan in the center of Useable area & not in center of the room.

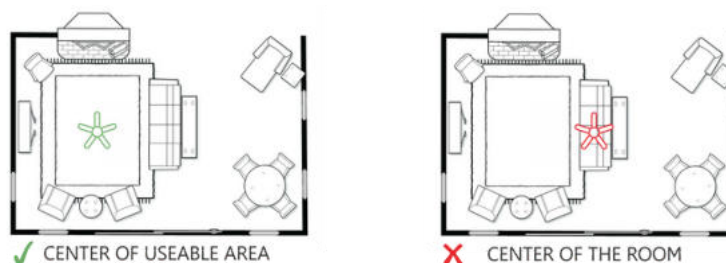

- Ceiling fans provide optimal airflow when hung at least 7.5 to 9 feet above the floor.
- Ceiling fan blades must hang at least 10 to 12 inches below the ceiling.
- Ceiling fan blades must be at least 24 inches away from wall, doors, cabinets, and posts.
- Confirm the location on the ceiling and the surrounding area is not cracked or damaged.



## INSTALLATION PROCEDURE ON FALSE/GYPSUM CEILING

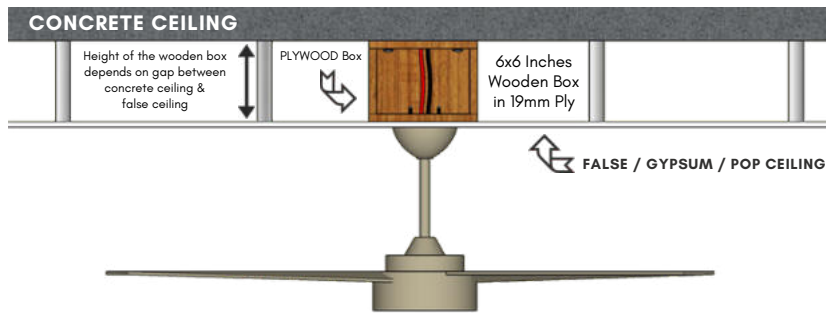

- Fix a wooden box between concrete ceiling and the false (gypsum) ceiling, secure the box on the concrete ceiling with screws.
- Install the false ceiling just touching the base of the wooden box.
- Fix the fan on the false ceiling with screws. The screws will fix securely on the wooden box, hence taking the entire weight of the fan.
- **Kindly note our controller will sit in the fan cup on the top, hence pre installed rods cannot be used to fix these fans. Designer fans can be fixed only on rods provided by the manufacturer.**

## INSTALLATION PROCEDURE ON WOODEN CEILING

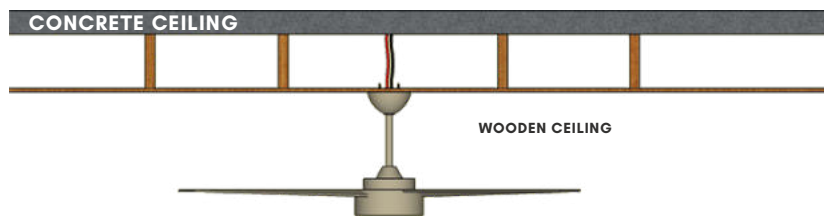

- Our fans can be directly installed on a false wooden ceiling
- A wooden ceiling of minimum 12mm plywood is required to install our fans directly, make sure the wooden ceiling is strong enough to take the weight of the fan

## INSTALLATION PROCEDURE ON CONCRETE CEILING

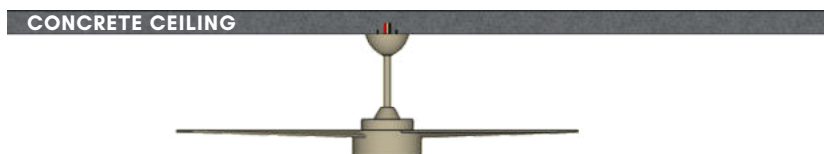

- Our Fans can be directly installed on a concrete ceiling. However if you have pre-installed FAN HOOK or FAN BOX in your concrete ceiling, you might need to purchase a fabricated clamp to install the fan properly. The fabricated clamp is available with us at an extra cost.
- Our fans can be fixed only on the rods & mounting kit provided along with the fan. Pre installed rods cannot be used to install designer fans including our fans.

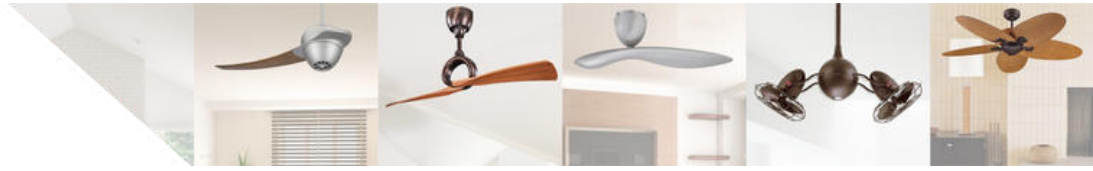

**DO NOT CONNECT THE FANS  
WITH REGULATOR / AUTOMATION DIMMER  
WORKS ONLY WITH INCLUDED REMOTE CONTROLLER**

## **WOBBLE**

- Always use the rods, hooks, clamps which came along with the fan, installing the fan on other hooks/rods/clamps might cause wobbling or noise.
- Ceiling fans tend to move during operation due to fact that they are not rigidly mounted. If they were, they could generate excessive ceiling vibration and stress on their mountings.
- Movement of a couple of centimetres is quite acceptable and does not suggest that the fan will fall down. • **WOBBLING OF FANS, BUMP IN THE NOISE OF THE FAN IS NOT COVERED UNDER WARRANTY**

## **BASIC INSTALLATION INSTRUCTIONS**

1. Make sure the ceiling, where the fan is to be installed is capable of taking atleast 45kgs load, also make sure the ceiling is even and straight. Uneven ceiling is one of the causes for fan wobbling & noise.
2. Kindly verify all the components are in place before assembling the fan.
3. Any designer fan including Our fans cannot be fitted on pre-installed rods.
4. Always use the rods, hooks, clamps which came along with the fan, installing the fan on other hooks/rods/clamps might cause wobbling or noise. In case of a ball type hook and clamp, make sure the ball sits securely in the groove of the clamp.
5. Never connect a remote and a regulator together for the same fan.
6. Never connect the fan to automation dimmer, power on-off is possible through automation, speed control is not possible. However few of the AC Motor fans can be speed controlled through automation. Please consult with us for such models.
7. Always use the remote and controller provided along with the fan, if other controller and remote is used, it might burn the motor.
8. Make sure the fan is rotating in the right direction. When you look from below the blades must rotate anti-clockwise. (blades must rotate from right to left).
9. For optimum air delivery, make sure the fan is atleast 7.5 to 9 feet above the ground and the blades are atleast 10 to 12 inches below the ceiling. Also make sure the fan blade is atleast 24 inches away from the closest wall.
10. To avoid any noise make sure all the screws and nuts are secured properly, no loose wires or components are left, no screws or nuts are left behind in motor housing or in light kit.

For any technical assistance Please call (Mon-Sat 11:00 Am to 6:00 Pm)

**+91 9844582500 | 9844572500**

**Kindly mention the correct fan model name while seeking assistance**

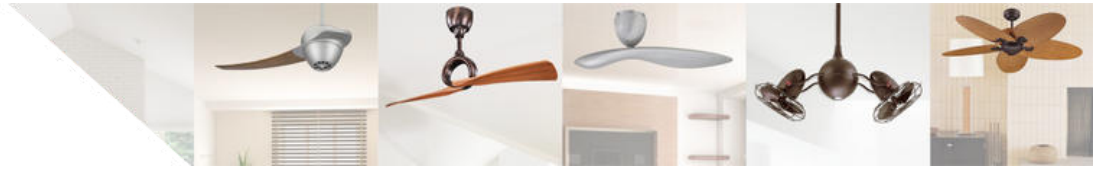

## UNDERSTANDING THE AIRFEEL MENTIONED IN OUR CATALOGUES

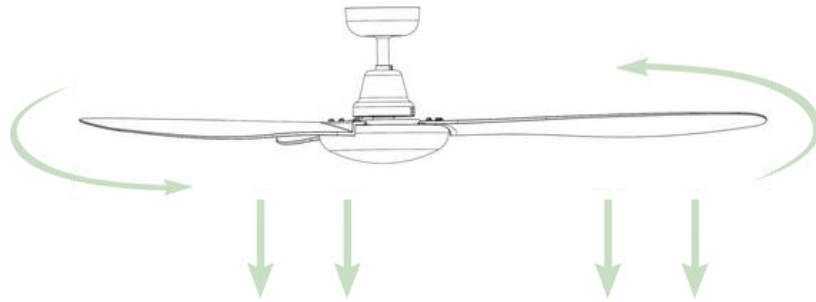

No. of Bars	WHAT IT INDICATES
9-10	VERY GOOD / EXCELLENT AIRFLOW
7-8	GOOD AIRFLOW
5-6	MEDIUM AIRFLOW
3-4	LOW AIRFLOW
1-2	TO BE USED AS DESIGNER ELEMENT

Airfeel 

As per our perception we have tried to give you a fair idea of the airflow of each of our fans.

Kindly note the Airflow perception of each individual is different, hence giving a Live demo of the fan to the client is Recommended.

## WHY IS THE CEILING FAN NOT GIVING ENOUGH AIR?

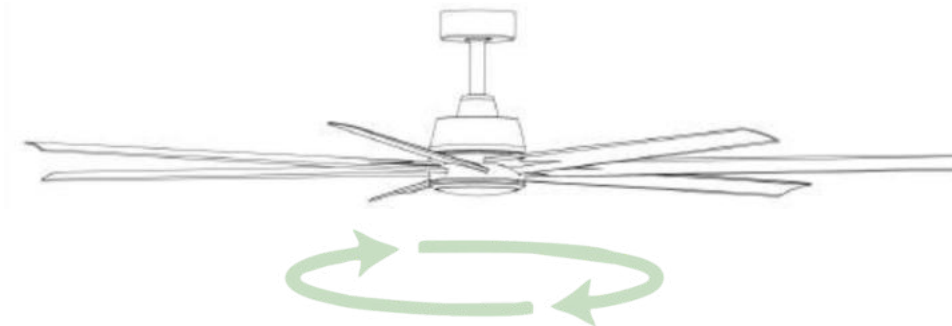

1. Check if the ceiling fan is rotating in the right direction. It should always rotate from RIGHT to LEFT. (Anti-Clockwise)
2. The size of the ceiling fan is not appropriate to the room size, the fan might be too small for the space. Most of the light dealers ask "how big is the room?" before recommending lights to their clients. Similarly, please ask the size of the room before recommending a Fan.
3. The Fan is not installed at the appropriate height. Its either installed too high or too low.
4. The Fan is installed too close to wardrobes, cabinet or other walls.
5. The Fan is installed far away from the service area.
6. You haven't checked the Airfeel Meter  before recommending the fan.

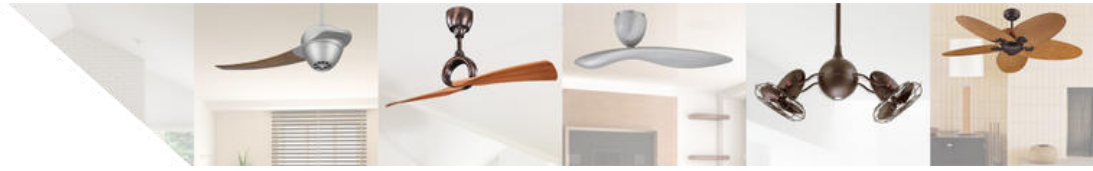

## CEILING FAN INSTALLATION SERVICE

**Our New Installation Service Price Is Only ₹1000/- For Your First Fan And Just ₹500/- Each For Any Additional Fans That You Need To Install\***

### **FAN INSTALLATION pricing includes:**

- Travel distance of 20km from the store where the fan is purchased. Locations beyond 20km will only be accepted by negotiation on travel time & distance.
- The site should be ready as per our requirement with the concrete/wooden/false/gypsum ceiling capable of taking minimum weight of 45kgs.
- Maximum 3m ceiling height.
- Any works outside this scope will be discussed & charged extra.

## TERMS & CONDITIONS

### **OUR RESPONSIBILITIES**

- Normal manufacturer's product warranty will be applicable.
- Installation will be performed by a qualified licensed electrician and may be an employee of Luft fans or an independent trained contractor as solely determined by us.
- The nominated contractor will contact you to book the installation date and time that is suitable to you but must be during normal weekday hours.
- Installation bookings may be made outside of normal business hours or weekends by mutual agreement, however, may incur a surcharge.
- If you have a complaint after installation you must provide evidence of that complaint and/or allow Luft fans or its preferred contractor access to your site.

### **YOUR RESPONSIBILITIES**

- You must have the fan/s at home with you in readiness for the installation.
- You must ensure that the product and installation service is suitable for your purpose and site. We are not liable if they are unsuitable.
- Any information you provide will be relied upon by us. You will be liable for any additional costs incurred if your representations are incorrect.
- You must ensure that the site is accessible and safe for the installer to attend and install the product.
- You must give us all relevant information about the site beforehand. You must provide the installer with access to the necessary areas and amenities as required.
- You confirm that you are the home owner or that you have authority from the home owner for the works to be undertaken. You must be at home during the installation.
- Your ceiling must be prepared and ready for installation as per our guidelines. Preparing the ceiling for installation is not under our scope.
- The fixed price installation offer is for installation of fans only and does not include the cost of any fans.

### **NOT INCLUDED**

- There may be circumstances where your new fan can't be installed as the ceiling would not be ready as per our requirement, In these situations, additional items may be required to complete the installation. Any additional works or items require the approval of the customer prior to commencement. Pricing and payment for any additional works should be negotiated directly between the customer and installer.
- At the completion of the installation, there may be some pre-existing issues that are visible such as drill holes, ceiling scratches and scuff marks. The repair of such issues does not fall under our scope.
- Any specialist equipment or tools required for installation, e.g. scaffolding or scissor lift, will be provided by the client and is not in our scope.

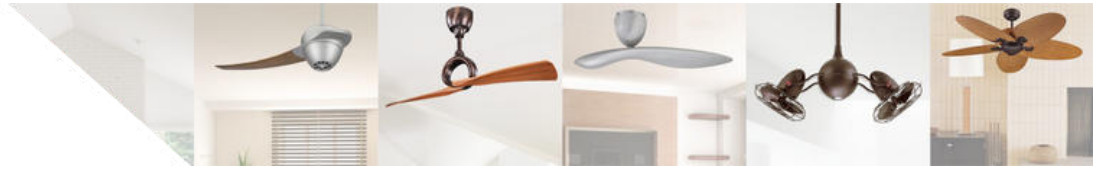

## **WARRANTY TERMS**

**WARRANTY IS VOID IF THE CEILING FAN IS NOT INSTALLED BY A TRAINED PERSON.**

**THERE IS NO ONSITE WARRANTY, THE FAN HAS TO BE SENT TO THE COMPANY FOR SERVICING, KINDLY PRODUCE THE PURCHASE DETAILS TO CLAIM WARRANTY.**

**The Following is NOT covered by warranty.**

- Damage from lighting or power surges, damage due to incorrect installation, Damage from over power delivery, water damage, damage arising due to improper power connection, and If installed or used outdoors.
- If used with automation dimmer or remote and regulator simultaneously.
- If Ceiling fans not installed by a licensed electrician.
- Ceiling fan used incorrectly, accidentally damaged, modified in any way or not serviced in accordance with the maintenance instructions.
- Burned motors / motor winding, fused bulbs, CFL tubes LED bulbs, remote and controllers are not covered under warranty. Batteries are not covered under warranty.
- Broken glass, broken blades or any other broken components or any other physical damage is not covered under warranty.
- Shipping cost incurred for sending the faulty fan and the replacement of new fan is not covered under warranty.
- Cost incurred in removal & reinstallation of the fan should be borne by the client.
- Cost incurred in renting of special equipments like ladder, scaffolding, scissors, lift etc., are not covered under warranty.
- Wobbling of fans, bump in the noise of the fan is not covered under warranty.
- Luft is liable to repair or service the faulty part. In rare case where the faulty part cannot be repaired the company will be liable only to replace the faulty component with a new one & is not obliged to refund the amount or replace the entire fan with a new one.

**ANY COMPLAINTS REGARDING MISSING COMPONENTS, MISSING PARTS, PHYSICAL DAMAGES, SCRATCHES, AND ANY OTHER CLARIFICATION WILL BE ENTERTAINED ONLY WITHIN 2 DAYS OF RECEIVING THE FAN, AFTER 2 DAYS COMPANY IS NOT RESPONSIBLE FOR THE SAME.**

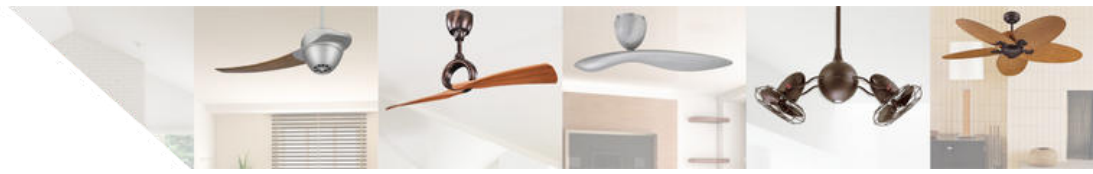





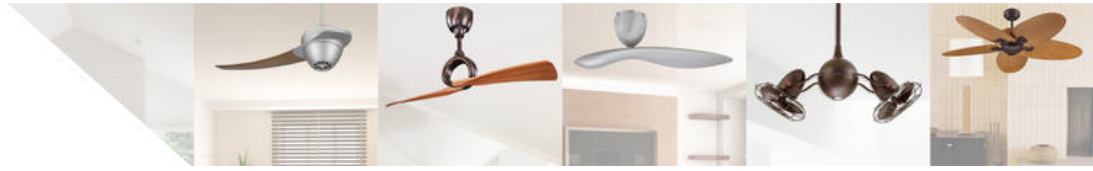



# VISUAL INDEX

<p><b>ACCURA</b></p>  <p>117</p>	<p><b>ACCURA HUGGER</b></p>  <p>119</p>	<p><b>AEROFORCE</b></p>  <p>135</p>	<p><b>AIRMOVER</b></p>  <p>063</p>	<p><b>ARIA</b></p>  <p>075</p>	<p><b>ARIA CTC</b></p>  <p>077</p>
<p><b>ATLANTA</b></p>  <p>029</p>	<p><b>BALI</b></p>  <p>037</p>	<p><b>BERLINETTA II</b></p>  <p>151</p>	<p><b>BIJOU</b></p>  <p>111</p>	<p><b>BREEZE FLOOR FAN</b></p>  <p>155</p>	<p><b>BREEZE PEDESTAL</b></p>  <p>153</p>
<p><b>CADILLAC</b></p>  <p>143</p>	<p><b>CADILLAC HUGGER</b></p>  <p>145</p>	<p><b>CADILLAC MINI</b></p>  <p>147</p>	<p><b>CADILLAC MINI HUGGER</b></p>  <p>149</p>	<p><b>CALYPSO</b></p>  <p>129</p>	<p><b>CAROLINA</b></p>  <p>039</p>
<p><b>CAROLINA XL</b></p>  <p>041</p>	<p><b>CAROLINA WALL MOUNT</b></p>  <p>043</p>	<p><b>CITRON II</b></p>  <p>121</p>	<p><b>CITRON II HUGGER</b></p>  <p>123</p>	<p><b>CLASSIC</b></p>  <p>021</p>	<p><b>CLIMATE DC</b></p>  <p>033</p>
<p><b>CLIMATE III</b></p>  <p>035</p>	<p><b>DAYTONA II</b></p>  <p>101</p>	<p><b>DAYTONA II HUGGER</b></p>  <p>103</p>	<p><b>ENIGMA</b></p>  <p>079</p>	<p><b>EVO 1</b></p>  <p>023</p>	<p><b>EVO 3</b></p>  <p>025</p>
<p><b>EVORA</b></p>  <p>017</p>	<p><b>FIJIAN II</b></p>  <p>069</p>	<p><b>FIJIAN II WALL MOUNT</b></p>  <p>071</p>	<p><b>FLUSSO</b></p>  <p>011</p>	<p><b>HAVANA</b></p>  <p>057</p>	<p><b>HAVANA WALL FAN TYPE 1</b></p>  <p>059</p>
<p><b>HAVANA WALL FAN TYPE 2</b></p>  <p>061</p>	<p><b>HEXAIR II</b></p>  <p>105</p>	<p><b>INDUSTRI</b></p>  <p>019</p>	<p><b>JETSTREAM</b></p>  <p>027</p>	<p><b>KODIAK</b></p>  <p>113</p>	<p><b>LAGOON</b></p>  <p>073</p>



# VISUAL INDEX

<p><b>LINE</b></p>  <p>001</p>	<p><b>LOUISVILLE</b></p>  <p>031</p>	<p><b>LUSSO II</b></p>  <p>095</p>	<p><b>LUSSO II HUGGER</b></p>  <p>097</p>	<p><b>MONTCLAIR</b></p>  <p>013</p>	<p><b>MONZA II HUGGER</b></p>  <p>099</p>
<p><b>MOONAH</b></p>  <p>109</p>	<p><b>NAUTICA</b></p>  <p>005</p>	<p><b>NEWPORT</b></p>  <p>051</p>	<p><b>NORDIC LED</b></p>  <p>055</p>	<p><b>PEREGRINE</b></p>  <p>003</p>	<p><b>QUEST II</b></p>  <p>045</p>
<p><b>RASER</b></p>  <p>085</p>	<p><b>RASER HUGGER</b></p>  <p>087</p>	<p><b>RESORT</b></p>  <p>083</p>	<p><b>RIVIERA</b></p>  <p>007</p>	<p><b>SCUDERIA</b></p>  <p>131</p>	<p><b>SCUDERIA HUGGER</b></p>  <p>133</p>
<p><b>SENSATION</b></p>  <p>047</p>	<p><b>RASER II CTC</b></p>  <p>081</p>	<p><b>SHOALHAVEN</b></p>  <p>049</p>	<p><b>SIERRA</b></p>  <p>115</p>	<p><b>STELLA</b></p>  <p>089</p>	<p><b>STELLA HUGGER</b></p>  <p>091</p>
<p><b>SWANK II</b></p>  <p>137</p>	<p><b>SWANK II HUGGER</b></p>  <p>139</p>	<p><b>SWANK II CTC</b></p>  <p>141</p>	<p><b>TAKEKO</b></p>  <p>053</p>	<p><b>TESTAROSSA II</b></p>  <p>125</p>	<p><b>TESTAROSSA II HUGGER</b></p>  <p>127</p>
<p><b>TYPE A</b></p>  <p>067</p>	<p><b>UNIONE</b></p>  <p>009</p>	<p><b>VEIL</b></p>  <p>015</p>	<p><b>VICEROY</b></p>  <p>065</p>	<p><b>XTREME</b></p>  <p>107</p>	<p><b>YANK FANDELIER</b></p>  <p>093</p>
<p><b>COMPACT AIR PURIFIER</b></p>  <p>157</p>	<p><b>VOLUME AIR PURIFIER</b></p>  <p>159</p>	<p><b>MAXI AIR PURIFIER</b></p>  <p>161</p>	<p><b>LUCCI CONNECT</b></p>  <p>163</p>	<p><b>ACCESSORIES</b></p>  <p>164</p>	<p><b>FUSION CURTAIN MOTOR</b></p>  <p>180</p>
<p><b>LÜFT CREATE</b></p>  <p>186</p>					

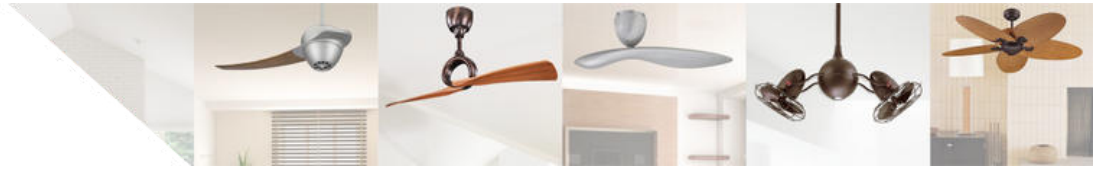

# VISUAL INDEX R2R

<p><b>OLIVIA INDUSTRIAL WALL FAN</b></p> 	<p><b>OLIVIA INDUSTRIAL PEDESTAL FAN</b></p>  <p>165</p>	<p><b>OLIVIA INDUSTRIAL MIST FAN</b></p>  <p>166</p>	<p><b>OLIVIA WATERPROOF WALL FAN</b></p>  <p>168</p>	<p><b>OLIVIA WALL, FLOOR, PEDESTAL FAN</b></p>  <p>167</p>	
<p><b>OLIVIA MIST PEDESTAL FAN</b></p>  <p>170</p>	<p><b>OLIVIA TWIN PEDESTAL FAN</b></p>  <p>169</p>	<p><b>ALPINE ULTRA MAX</b></p>  <p>171</p>	<p><b>ALPINE PLUS TOWER FAN 48"</b></p>  <p>172</p>		<p><b>ALPINE GRAND 48"</b></p>  <p>173</p>
<p><b>VENTIANA EXHAUST</b></p> 			<p><b>VIPER EXHAUST</b></p> 		<p><b>VANTAGE MIXFLOW INLINE EXHAUST</b></p> 
<p><b>ELIZA CEILING EXHAUST</b></p> 	<p><b>ELIZA-BTS</b></p> 	<p><b>ELIZA-PRO</b></p>  <p>176</p>	<p><b>ZENVO EXHAUST</b></p> 		<p><b>VANTAGE SUEER SILENT</b></p>  <p>177</p>
<p><b>ACCESSORIES</b></p>  <p>178</p>					

## WHY USE AN EXHAUST FAN?





Black

*Remote Control  
Included*



White

## LUCCIAR

**Fan Size 52"**

**Fan Material**

**Metal/ABS**

**Motor DC**

**Airflow**

**194m<sup>3</sup>/min**

**Approx Height 12"/14"**

**Airfeel**



# LINE

INDEX

002

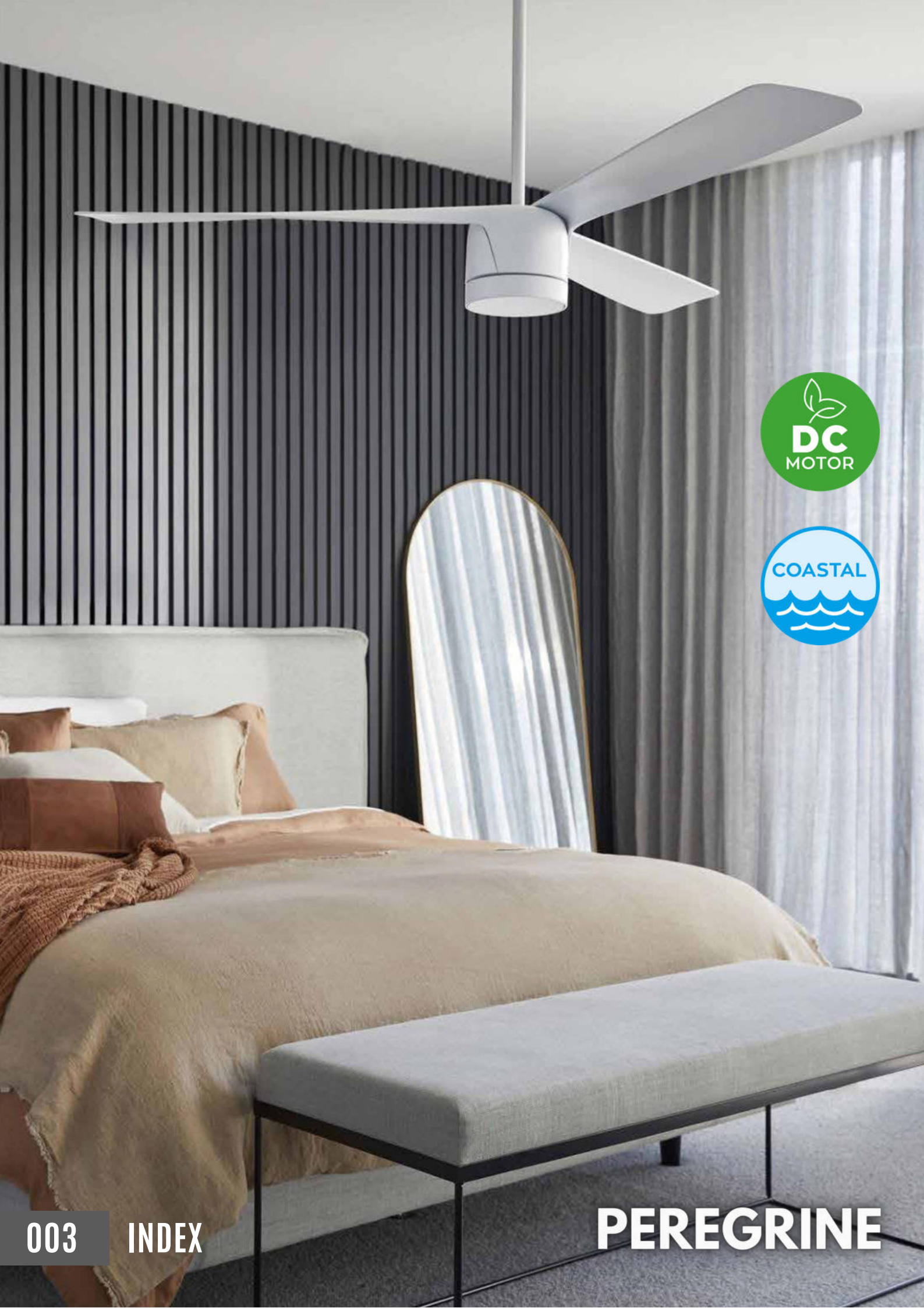



*Remote Control  
Included*



## LUCCIAR

**Fan Size 56"**

**Fan Material**

**Metal/ABS**

**Motor DC**

**Airflow**

**181m<sup>3</sup>/min**

**Approx Height 10"/15"**

**Airfeel**



# PEREGRINE

INDEX

004





Brushed Nickel  
With Teak Blades



Black

*Remote Control  
Included*



White

## LUCCIAR

**Fan Size 52"**

**Fan Material**

**Metal/ABS**

**Motor DC**

**Airflow**

**212m<sup>3</sup>/min**

**Approx Height 11"/12"**

**Airfeel**



# NAUTICA

INDEX

006





Black

*Remote Control  
Included*



White

## LUCCIAR

**Fan Size 52"**

**Fan Material**

**Metal/ABS**

**Motor DC**

**Airflow**

**204m<sup>3</sup>/min**

**Approx Height 11"**

**Airfeel**



# RIVIERA

INDEX

008





ORB/Koa

*Remote Control  
Included*



Aged Nickel/Koa

## LUCCIAR

**Fan Size 56"**

**Fan Material**

**Steel+ABS/ABS**

**Motor DC**

**Airflow**

**186m<sup>3</sup>/min**

**Approx Height 12"/13"**

**Airfeel**



# UNIONE

INDEX

010





ORB

*Remote Control  
Included*



White

## LUCCIAR

**Fan Size 52"**

**Fan Material**

**Plywood/ABS**

**Motor DC**

**Airflow**

**187m<sup>3</sup>/min**

**Approx Height 9"/13"**

**Airfeel**



# FLUSSO

INDEX

012





Black/Koa  
With Smoked Blades

Remote Control  
Included



When Closed



Bottom View



FANAWAY

**Fan Size 48"**

**Fan Material**

**Plastic+Steel/ABS**

**Motor AC**

**Airflow**

**118m<sup>3</sup>/Min**

**Approx Height 12"/18"**

**Airfeel**



# MONTCLAIR





Black with Smoke  
Coloured Retractable  
Blades & Light



Chrome with  
Clear Retractable  
Blades & Light

*Remote Control  
Included*



FANAWAY

**Fan Size 48"**

**Fan Material**

**Metal/PC**

**Motor AC**

**Airflow**

**180m<sup>3</sup>/Min**

**Approx Height 12"/20"**

**Airfeel**



WhenClosed



Bottom View

**VEIL**





Black

Remote Control  
Included



ORB



Brushed Chrome



White



FANAWAY

**Fan Size 36"**

**Fan Material**

**Metal/PC**

**Motor AC**

**Airflow**

**120m<sup>3</sup>/Min**

**Approx Height 12"/20"**

**Airfeel**



WhenClosed



Bottom View

**EVORA**

INDEX

018





Black/Koa  
With Smoked Blades

Remote Control  
Included



When Closed



FANAWAY

**Fan Size 48"**

**Fan Material**

**Metal/ABS**

**Motor AC**

**Airflow**

**180m<sup>3</sup>/Min**

**Approx Height 12"/19"**

**Airfeel**



**INDUSTRI**

**INDEX**

**020**



PATENT  
TECHNOLOGY



Black

Remote Control  
Included



When Closed



Bottom View



FANAWAY

**Fan Size 48"**

**Fan Material**

**Metal/PC**

**Motor AC**

**Airflow**

**180m<sup>3</sup>/Min**

**Approx Height 12"/19"**

**Airfeel**



**CLASSIC**

**INDEX**

**022**



3 Tone LED Light  
(Dimmable)





Brushed Chrome - LED



White LED

*Remote Control  
Included*



White T5 Tube



FANAWAY

**Fan Size 48"**

**Fan Material**

**Metal/Acrylic**

**Motor AC**

**Airflow**

**180m<sup>3</sup>/Min**

**Approx Height 15"**

**Airfeel**



**STOCK CLEARANCE**

**EVO 1**

**INDEX**

**024**



025

INDEX

EVO 3



Brushed Chrome

*Remote Control  
Included*



When Closed



FANAWAY

**Fan Size 48"**

**Fan Material**

**Metal/Acrylic**

**Motor AC**

**Airflow**

**186m<sup>3</sup>/Min**

**Approx Height 15"**

**Airfeel**



**STOCK CLEARANCE**

**EVO 3**

**INDEX**

**026**





*Remote Control  
Not Included*



**Fan Size 58"**

**Fan Material**

**ABS/ABS**

**Motor AC**

**Airflow**

**238m<sup>3</sup>/min**

**Approx Height 14"**

**Airfeel**



**JETSTREAM**

**INDEX**

**028**





Matt Black With  
Black Blades

*Remote Control  
Included*



White

## LUCCIAR

**Fan Size 56"**

**Fan Material**

**Metal/ABS**

**Motor DC**

**Airflow**

**267m<sup>3</sup>/min**

**Approx Height 14"**

**Airfeel**



# ATLANTA

INDEX

030





Oil Rubbed  
Bronze

*Remote Control  
Included*



## LUCCIAR

**Fan Size 62"**

**Fan Material**

**Metal/Plywood**

**Motor DC**

**Airflow**

**267m<sup>3</sup>/min**

**Approx Height 15"**

**Airfeel**



# LOUISVILLE

INDEX

032





White

*Remote Control  
Included*



Brushed  
Chrome Silver

Light Kit



## LUCCIAR

**Fan Size 52"**

**Fan Material**

**Metal/Plywood**

**Motor DC**

**Airflow**

**176m<sup>3</sup>/min**

**Approx Height 13"**

**Airfeel**



**STOCK CLEARANCE**

# CLIMATE DC

INDEX

034





Black

Reversible Blades

Remote Control  
Included



Black with  
Wood

Light Kit



## LUCCIAR

**Fan Size 52"**

**Fan Material**

**Plywood+Steel/Plywood**

**Motor DC**

**Airflow**

**197m<sup>3</sup>/min**

**Approx Height 13"**

**Airfeel**



# CLIMATE III

INDEX

036





ORB/Koa

*Remote Control  
Included*



Antique White

## LUCCIAR

**Fan Size 52"**

**Fan Material**

**Metal/ABS**

**Motor DC**

**Airflow**

**160m<sup>3</sup>/min**

**Approx Height 15"**

**Airfeel**



# BALI

INDEX

038





ORB with  
DK Blades



Black

*Remote Control  
Not Included*



White

## LUCCIAR

**Fan Size 56"**

**Fan Material**

**Metal/ABS**

**Motor AC**

**Airflow**

**235m<sup>3</sup>/Min**

**Approx Height 14"**

**Airfeel**



# CAROLINA

INDEX

040





ORB with  
DK Blades



Black

*Remote Control  
Not Included*



White

## LUCCIAR

**Fan Size 72"**

**Fan Material**

**Metal/ABS**

**Motor AC**

**Airflow**

**283m<sup>3</sup>/Min**

**Approx Height 14"**

**Airfeel**



# CAROLINA XL



# CAROLINA WALL MOUNT



ORB with  
DK Blades

*Remote Control  
Not Included*



## LUCCIAR

**Fan Size 56"**

**Fan Material**

**Metal/ABS**

**Motor AC**

**Airflow**

**200m<sup>3</sup>/Min**

**Approx Height 15"**

**Airfeel**



# CAROLINA WALL MOUNT





Black



Oak / White

*Remote Control  
Not Included*



White

## LucciAR

**Fan Size 52"**

**Fan Material**

**Metal/Plywood**

**Motor AC**

**Airflow**

**213m<sup>3</sup>/Min**

**Approx Height 12"**

**Airfeel**



**STOCK CLEARANCE**

# QUEST II

INDEX

046





Black

*Remote Control  
Not Included*



## LucciAR

**Fan Size 54"**

**Fan Material**

**Metal/ABS**

**Motor AC**

**Airflow**

**216m<sup>3</sup>/min**

**Approx Height 12"**

**Airfeel**



**STOCK CLEARANCE**

# SENSATION

INDEX

048





Brushed Chrome  
LED

*Remote Control  
Included*



## LUCCIAR

**Fan Size 56"**

**Fan Material**

**Steel/Wood**

**Motor AC**

**Airflow**

**214m<sup>3</sup>/min**

**Approx Height 14"**

**Airfeel**



# SHOALHAVEN

INDEX

050





**With Reversible Blades  
& LED Light**

Antique Black  
With Aged Wood/Black Blades



*Remote Control  
Included*



Antique White  
With Oak Wood Blades

## LUCCIAR

**Fan Size 54"**

**Fan Material**

**ABS/Plywood**

**Motor DC**

**Airflow**

**210m<sup>3</sup>/Min**

**Approx Height 14"**

**Airfeel**



# NEWPORT

INDEX

052





White



Black/Koa

*Remote Control  
Not Included*



## LucciAR

**Fan Size 65"**

**Fan Material**

**Metal/ABS**

**Motor AC**

**Airflow**

**275m<sup>3</sup>/Min**

**Approx Height 13"**

**Airfeel**



**STOCK CLEARANCE**

**TAKEKO**

**INDEX**

**054**



055 INDEX

**NORDIC LED**



ORB Wood LED

*Remote Control  
Included*



Black

## LucciAR

**Fan Size 56"**

**Fan Material**

**Metal/Plywood**

**Motor DC**

**Airflow**

**201m<sup>3</sup>/Min**

**Approx Height 13"**

**Airfeel**



**STOCK CLEARANCE**

# NORDIC LED

INDEX

056





ORB With  
DK Blades



White With  
Oak Blades



Black

*Remote Control  
Included*



## LUCCIAR

**Fan Size 15"**

**Fan Material**

**Metal/ABS**

**Motor AC**

**Airflow**

**86m<sup>3</sup>/Min**

**Approx Height 22"**

**Airfeel**



Also Available in  
**HUGGER MODEL**

# HAVANA



# HAVANA WALL FAN TYPE 1

059

INDEX



Black



White With  
Oak Blades



ORB With  
DK Blades

*Remote Control  
Included*



## LUCCIAR

**Fan Size 15"**

**Fan Material**

**Metal/ABS**

**Motor AC**

**Airflow**

**86m<sup>3</sup>/Min**

**Approx Height 22"**

**Airfeel**



# HAVANA WALL FAN TYPE 1



# HAVANA WALL FAN TYPE 2



ORB With  
DK Blades



White With  
Oak Blades



Black

*Remote Control  
Included*



## LUCCIAR

**Fan Size 15"**

**Fan Material**

**Metal/ABS**

**Motor AC**

**Airflow**

**86m<sup>3</sup>/Min**

**Approx Height 20"**

**Airfeel**



# HAVANA WALL FAN TYPE 2





White

*Remote Control  
Not Included*



## LUCCIAR

**Fan Size 56"**

**Fan Material**

**Metal/ABS**

**Motor AC**

**Airflow**

**260m<sup>3</sup>/Min**

**Approx Height 13"**

**Airfeel**



# AIRMOVER

INDEX

064





Black



White Teak

*Remote Control  
Included*



White

## LUCCIAR

**Fan Size 52"**

**Fan Material**

**Metal/ABS**

**Motor DC**

**Airflow**

**215m<sup>3</sup>/Min**

**Approx Height 13"**

**Airfeel**



**STOCK CLEARANCE**

# VICEROY

INDEX

066





Dark Koa



Black

*Remote Control  
Included*



White Teak

## LUCCIAR

**Fan Size 60"**

**Fan Material**

**Metal/ABS**

**Motor DC**

**Airflow**

**281m<sup>3</sup>/Min**

**Approx Height 13"**

**Airfeel**



Light Kit



# TYPE A

INDEX

068





Brown - Wood  
Color

*Remote Control  
Not Included*



Off White



Dark Coffee

## LUCCIAR

**Fan Size 52"**

**Fan Material**

**Metal/ABS**

**Motor AC**

**Airflow**

**189m<sup>3</sup>/Min**

**Approx Height 16"**

**Airfeel**



# FIJIAN II

INDEX

070





Brown - Wood  
Color

*Remote Control  
Not Included*



## LUCCIAR

**Fan Size 52"Fan**

**Material**

**Metal/ABSMotor**

**ACAirflow**

**189m3/Min**

**Approx**

**Height-NA**

**Airfeel**



# FIJIAN II WALL MOUNT

INDEX

072





Black



White

*Remote Control  
Not Included*



Black CTC



**Fan Size 52"**

**Fan Material**

**Metal/ABS**

**Motor AC**

**Airflow**

**160m<sup>3</sup>/Min**

**Approx Height 12"**

**Airfeel**



**LAGOON**

**INDEX**

**074**



075 INDEX

ARIA



White

*Remote Control  
Not Included*



## LUCCIARIA

**Fan Size 48"**

**Fan Material**

**Metal/ABS**

**Motor AC**

**Airflow**

**156m<sup>3</sup>/Min**

**Approx Height 12"/8"**

**Airfeel**



# ARIA

INDEX

076





Aria CTC Black

*Remote Control  
Included*



Aria CTC White

## LUCCIAR

**Fan Size 48"**

**Fan Material**

**Metal/ABS**

**Motor AC**

**Airflow**

**156m<sup>3</sup>/Min**

**Approx Height 12"/8"**

**Airfeel**



# ARIA CTC

INDEX

078





Metro Grey with  
Walnut Blade

*Remote Control  
Included*



**Fan Size 60"**

**Fan Material**

**Metal/ABS**

**Motor DC**

**Airflow**

**164m3/Min**

**Approx Height 19"**

**Airfeel**



**STOCK CLEARANCE**

**ENIGMA**

**INDEX**

**080**





AB Wood

*Remote Control  
Included*



Black with Wood



Matte White

**Fan Size 52"/46"**

**Fan Material**

**Metal/Wood**

**Motor DC**

**Airflow**

**190m<sup>3</sup>/Min**

**Approx Height 8"**

**Airfeel**

**RASER II  
CTC**







White

*Remote Control  
Included*



# HVLS Fan

High Volume Low Speed

LUCCIAR

**Fan Size 80"**

**Fan Material**

**Metal/Aluminum**

**Motor DC**

**Airflow**

**330m<sup>3</sup>/Min**

**Approx Height 14"**

**Airfeel**



# RESORT

INDEX

084





Antique Brass Wood

Remote Control  
Included



Matte Black



Wood Finish



Matte White



BC Teak

**Fan Size 52"/46"**

**Fan Material**

**Metal/Wood**

**Motor DC**

**Airflow**

**190m<sup>3</sup>/Min**

**Approx Height 14"**

**Airfeel**



Light Kit



**RASER**

**INDEX**

**086**



NO ONE  
IS YOU  
AND THAT  
IS YOUR  
POWER

**RASER  
HUGGER**



Antique Brass Wood

Remote Control  
Included



Matte Black



Wood Finish



Matte White



BC Teak

Light Kit



**Fan Size 52"/46"**

**Fan Material**

**Metal/Wood**

**Motor DC**

**Airflow**

**190m<sup>3</sup>/Min**

**Approx Height 9"**

**Airfeel**



# RASER HUGGER

INDEX

088





Antique Brass  
Walnut

Remote Control  
Included



Satin Nickel  
with Dark Wood



Black with Teak



Black with  
Wood Finish



Satin Nickel  
with Teak

**Fan Size 52" / 46" / 40" / 34" / 28"**

**Fan Material**

**Metal/Wood**

**Motor DC**

**Airflow**

**250m3/Min**

**Approx Height 16"**

**Airfeel**



Also Available in  
**HUGGER MODEL**

**STELLA**

**INDEX**

**090**





Antique Brass with  
Black / Walnut

*Remote Control  
Included*



Steel with  
Black / Wood



Copper with  
Black / Wood



Teak with Steel



Black with  
Teak / Wood



Matte Black



Matte White

**Fan Size 52" / 46" / 40" / 34" / 28"**

**Fan Material**

**Metal/Wood**

**Motor DC**

**Airflow**

**250m<sup>3</sup>/Min**

**Approx Height 8"**

**Airfeel**

**STELLA  
HUGGER**





# YANK ANTIQUE FANDELIER

093

INDEX



Antique ORB

*Remote Control  
Included*



**Fan Size 34"**

**Fan Material**

**Metal/ABS**

**Motor AC**

**Airflow**

**75m<sup>3</sup>/Min**

**Approx Height 26"**

**Airfeel**



**STOCK CLEARANCE**

# YANK ANTIQUE FANDELIER

INDEX

094





Antique Brass walnut 60"

*Remote Control  
Included*



Antique Brass  
Wood 52"



Satin Nickel  
Wood 52"



Wood Black 36"



Walnut Black 36"

**Fan Size 60" / 52" / 36"**

**Fan Material**

**Metal/ABS**

**Motor DC**

**Airflow**

**250m<sup>3</sup>/Min**

**Approx Height 16"**

**Airfeel**



**LUSSO II**

**INDEX**

**096**





Antique Brass walnut 60"

*Remote Control  
Included*



Antique Brass  
Wood 52"



Satin Nickel  
Wood 52"



Wood Black 36"



Walnut Black 36"

**Fan Size 60" / 52" / 36"**

**Fan Material**

**Metal/ABS**

**Motor DC**

**Airflow**

**250m3/Min**

**Approx Height 9"**

**Airfeel**



**LUSO II  
HUGGER**



**MONZA II  
HUGGER**



Brushed Chrome  
Walnut

Remote Control  
Included



Brushed Chrome  
Natural Wood



Antique Brass  
Walnut

Light Kit



**Fan Size 52"/46"**

**Fan Material**

**Metal/Wood**

**Motor DC**

**Airflow**

**190m<sup>3</sup>/Min**

**Approx Height 9"**

**Airfeel**



# MONZA II HUGGER





*Remote Control  
Included*



Antique Brass Wood



Wood Finish



Black with  
Wood



Matte Black



Matte White

**Fan Size 52"**

**Fan Material**

**Metal/ABS**

**Motor DC**

**Airflow**

**250m<sup>3</sup>/Min**

**Approx Height 16"**

**Airfeel**



Light Kit



# DAYTONA II



# DAYTONA II HUGGER



Antique Brass  
Wood

*Remote Control  
Included*



Wood Finish



Matte Black



Black with  
Wood



Matte White

Light Kit



**Fan Size 52"**

**Fan Material**

**Metal/ABS**

**Motor DC**

**Airflow**

**250m<sup>3</sup>/Min**

**Approx Height 9"**

**Airfeel**



# DAYTONA II HUGGER





*Remote Control  
Included*



Antique Brass  
Wood Finish LED



Antique Brass Wood Finish  
without LED



Antique Brass Wood Finish  
Hugger LED



Antique Brass Wood Finish  
Hugger without LED

# HVLS Fan

High Volume Low Speed

**Fan Size 66"Fan**

**Material**

**Metal/Acrylic**

**Motor DCAirflow**

**230m3/Min**

**Approx Height**

**12/18"**

**Airfeel**



# HEXAIR II





Wood Finish



Matte Black

*Remote Control  
Included*



Matte White

# HVLS Fan

High Volume Low Speed

**Fan Size 7.5' / 8' / 8.5' / 9'**

**Fan Material**

**Metal/Aluminum**

**Motor AC**

**Airflow**

**320m3/Min**

**Approx Height 21"**

**Airfeel**



# XTREME





Silver

*Remote Control  
Included*



White

## LUCCIAR

**Fan Size 52"**

**Fan Material**

**Metal/ABS**

**Motor AC**

**Airflow**

**216m<sup>3</sup>/Min**

**Approx Height 13"**

**Airfeel**



**STOCK CLEARANCE**

# MOONAH





Black

*Remote Control  
Included*



White



**Fan Size 32"Fan**  
**Material**  
**Metal/ABS**  
**Motor**  
**ACA**  
**Airflow**  
**176m<sup>3</sup>/min**  
**Approx Height**  
**14/8"**  
**Airfeel**



Also Available in  
**HUGGER MODEL**

**BIJOU**

**INDEX**

**112**





Wood

*Remote Control  
Included*



White



**Fan Size 54"**

**Fan Material**

**Metal/ABS Motor**

**ACAirflow**

**176m<sup>3</sup>/min**

**Approx Height**

**14"/8**

**Airfeel**



Also Available in  
**HUGGER MODEL**

**KODIAK**





Wood



White

*Remote Control  
Included*



Also Available in  
**HUGGER MODEL**

**Fan Size 54" Fan**  
**Material**  
Metal/Plywood  
**Motor DCAirflow**  
**176m<sup>3</sup>/min**  
**Approx Height**  
**14/8"**  
**Airfeel**



**SIERRA**





Antique Brass Wood

*Remote Control  
Included*



Matte White



Matte Black



Wood Finish



Black with  
AshWood Grey

**Fan Size 54"**

**Fan Material**

**Metal/ABS**

**Motor DC**

**Airflow**

**270m<sup>3</sup>/Min**

**Approx Height 14"**

**Airfeel**



**ACCURA**

**INDEX**

**118**





Wood Finish

*Remote Control  
Included*



Matte Black



Matte White

**Hugger Canopy Available  
for all colours**

**Fan Size 54"**

**Fan Material**

**Metal/ABS**

**Motor DC**

**Airflow**

**270m<sup>3</sup>/Min**

**Approx Height 9"**

**Airfeel**



**ACCURA  
HUGGER**





Wood Finish

*Remote Control  
Included*



Black with  
Wood



Matte White

Light Kit



**Fan Size 48"**

**Fan Material**

**Metal/ABS**

**Motor DC**

**Airflow**

**195m<sup>3</sup>/Min**

**Approx Height 13"**

**Airfeel**



**CITRON II**



**CITRON II  
HUGGER**



Wood Finish

*Remote Control  
Included*



Black with  
Wood



Matte White

Light Kit



**Fan Size 48" Fan**

**Material**

**Metal/ABS**

**Motor DCAirflow**

**195m<sup>3</sup>/Min**

**Approx Height 9"**

**Airfeel**



# CITRON II HUGGER





*Remote Control  
Included*



Antique Brass Wood



Black Wood



Black with Teak



Brushed Chrome Teak

Light Kit



**Fan Size 52"**

**Fan Material**

**Metal/Wood**

**Motor DC**

**Airflow**

**220m<sup>3</sup>/Min**

**Approx Height 16"**

**Airfeel**



# TESTAROSSA II



**TESTAROSSA II  
HUGGER**



*Remote Control  
Included*



Antique Brass Wood



Black Wood



Black with Teak



Brushed Chrome Teak

Light Kit



**Fan Size 52"**

**Fan Material**

**Metal/Wood**

**Motor DC**

**Airflow**

**220m<sup>3</sup>/Min**

**Approx Height 9"**

**Airfeel**



# TESTAROSSA II HUGGER





Black

*Remote Control  
Not Included*



**Fan Size 48"**

**Fan Material**

**Metal/ABS**

**Motor AC**

**Airflow**

**150m<sup>3</sup>/Min**

**Approx Height 12"**

**Airfeel**



**CALYPSO**

**INDEX**

**130**





Antique Brass  
Wood

*Remote Control  
Included*



Wood Finish



Ash-Grey Black



Matte Black



Matte White

**Fan Size 52"**

**Fan Material**

**Metal/ABS**

**Motor AC/DC (Limited Stocks)**

**Airflow**

**280m<sup>3</sup>/Min**

**Approx Height 14"**

**Airfeel**



**SCUDERIA**



**SCUDERIA  
HUGGER**



Matte Black

*Remote Control  
Included*



Ash-Grey Black



Wood Finish



Matte Black



Matte White

**Fan Size 52"Fan**  
**Material**  
**Metal/ABS**  
**Motor DC**  
**Airflow**  
**280m3/Min**  
**Approx Height 9"**  
**Airfeel**

**Hugger Canopy Available  
for all colours**

# SCUDERIA HUGGER







Shadow  
Chrome - White

*Remote Control  
Not Included*



**Fan Size 52"**

**Fan Material**

**Metal/Polymer**

**Motor AC**

**Airflow**

**230m3/Min**

**Approx Height 12"**

**Airfeel**



**STOCK CLEARANCE**

**AEROFORCE**



*Remote Control  
Included*



Black with  
Wood



Antique Brass Wood



Wood Finish



Brushed  
Chrome Teak



Matte Black



Matte White

Light Kit



**Fan Size 37"**

**Fan Material**

**Metal/ABS**

**Motor DC**

**Airflow**

**147m<sup>3</sup>/Min**

**Approx Height 15"**

**Airfeel**



# SWANK II



# SWANK II HUGGER



Matte Black

Remote Control  
Included



Antique Brass  
Wood



Black with  
Wood



Wood Finish



Brushed  
Chrome Teak



Matte White

Light Kit



**Fan Size 36"**

**Fan Material**

**Metal/ABS**

**Motor DC**

**Airflow**

**147m<sup>3</sup>/Min**

**Approx Height 9"**

**Airfeel**



# SWANK II HUGGER



**SWANK II  
CTC**



Antique Brass  
Wood

*Remote Control  
Included*



Steel Wood



Black Wood

**Fan Size 36"**

**Fan Material**

**Metal/ABS**

**Motor DC**

**Airflow**

**147m<sup>3</sup>/Min**

**Approx Height 9"**

**Airfeel**



**SWANK II  
CTC**





Brushed Chrome  
Wood

*Remote Control  
Included*



Wood Finish



Antique Brass  
Black



Matte Black



Matte White



Ash-Grey Black

**Fan Size 52"**

**Fan Material**

**Metal/ABS**

**Motor DC**

**Airflow**

**230m3/Min**

**Approx Height 13"**

**Airfeel**



**CADILLAC**



**CADILLAC  
HUGGER**



Matte Black

*Remote Control  
Included*



Ash-Grey Black



Wood Finish



Matte White

**Fan Size 52"**

**Fan Material**

**Metal/ABS**

**Motor DC**

**Airflow**

**180m<sup>3</sup>/Min**

**Approx Height 9"**

**Airfeel**



**Hugger Canopy Available  
for all colours**

# CADILLAC HUGGER





Wood Finish



Matte Black

*Remote Control  
Included*



Matte White

**Fan Size 40"**

**Fan Material**

**Metal/ABS**

**Motor DC**

**Airflow**

**230m<sup>3</sup>/Min**

**Approx Height 12"**

**Airfeel**



# CADILLAC MINI



# CADILLAC MINI HUGGER



Matte Black

*Remote Control  
Included*



Wood Finish



Matte White

**Fan Size 40"**

**Fan Material**

**Metal/ABS**

**Motor DC**

**Airflow**

**230m<sup>3</sup>/Min**

**Approx Height 9"**

**Airfeel**

**Hugger Canopy Available  
for all colours**

# CADILLAC MINI HUGGER





3 Tone LED Light  
(Dimmable)



Wood Finish  
with LED

*Remote Control  
Included*



Wood without  
Light



Axis Grey-Black



Matte Black  
with LED



Matte White  
with LED

**Fan Size 52"**

**Fan Material**

**Metal/ABS**

**Motor DC**

**Airflow**

**220m3/Min**

**Approx Height 18"**

**Airfeel**



# BERLINETTA II



**BREEZE  
PEDESTAL**



ORB



Black



Brushed  
Chrome

*Remote Control  
Not Included*



## LUCCIAR

**Fan Size 16"**

**Fan Material**

**Metal/ABS**

**Motor AC**

**Airflow**

**59m<sup>3</sup>/Min**

**Approx Height 59"**

**Airfeel**



# BREEZE PEDESTAL



**BREEZE  
FLOOR FAN**



ORB

*Remote Control  
Not Included*



Black

## LUCCI AIR

**Fan Size 16"**

**Fan Material**

**Metal/ABS**

**Motor AC**

**Airflow**

**64m<sup>3</sup>/Min**

**Approx Height 19"**

**Airfeel**



# BREEZE FLOOR FAN



# COMPACT AIR PURIFIER

# COMPACT AIR PURIFIER H13

## LUCCIAR



### SPECS

- Size 195 X 195 X 402mm
- Colour White with black detail
- Modes High/Medium/Low
- Rated voltage 220-240V~, 50/60Hz
- Rated wattage 35W
- Max. Airflow/CADR 90m<sup>3</sup>/h
- Coverage Area ≤ 11m<sup>2</sup>
- Filter type Replaceable H13 HEPA ALL IN ONE  
(Included / replaced filter sold separately)
- Filter life 2200 hours
- Noise level < 50 dB on high
- Timer 2/4/8 hours
- Night Light N/A
- Child Lock N/A
- Insulation class Class II
- Plug & Play Yes
- IP rating IP20
- Certification CE by Waltek



# VOLUME AIR PURIFIER

# VOLUME AIR PURIFIER H13

LUCCIAR



## SPECS

Size 195 X 195 X 388mm

Colour White with black detail

Modes High/Medium/Sleep

Rated voltage 100-240V~, 50/60Hz

Rated wattage 23W

Max. Airflow/CADR 130m<sup>3</sup>/h

Coverage Area ≤ 16m<sup>2</sup>

Filter type Replaceable H13 HEPA ALL IN ONE

(Included / replaced filter sold separately)

Filter life 2200 hours

Noise level < 50 dB on high

Timer 2/4/8 hours

Night Light N/A

Child Lock N/A

Insulation class Class II (Power adaptor included)

Plug & Play Yes

IP rating IP20

Certification CE by Waltek

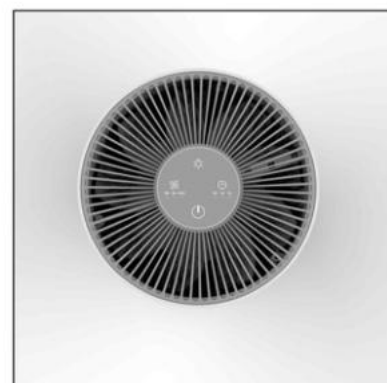



**MAXI  
AIR PURIFIER**

# MAXI AIR PURIFIER H13

## LUCCIAR



### SPECS

Size 270 X 303 X 497mm

Colour White with black detail

Modes High/Medium/Sleep

Rated voltage 220-240V~, 50/60Hz

Rated wattage 50W

Max. Airflow/CADR 400m<sup>3</sup>/h

Coverage Area ≤ 50m<sup>2</sup>

Filter type Replaceable H13 HEPA ALL IN ONE  
(Included / replaced filter sold separately)

Filter life 2200 hours

Noise level < 50 dB on high

Timer 2/4/8 hours

Night Light Yes

Child Lock Yes

Insulation class Class II

Plug & Play Yes

IP rating IP20

Certification CE by Waltek

# LUCCI CONNECT WIFI REMOTE

LUCCI AIR



Lucci Connect allows you to control your fan like never before. This Smart Fan Remote will allow you to control your fan with the remote and from your phone. Set up and control is simple with the easy to use Lucci Connect app. Combine with a smart home hub to enable voice control access and immerse yourself in the ultimate smart home experience.



#### SPECS

- Dimensions 42 x 12 x 110 mm
- Speed Low / Medium / High
- Light on/off
- Only compatible with AC Motor fans



**LUCCI / LUFT REMOTE  
CONTROL FOR AC MOTOR  
FANS**



**LUFT REMOTE  
CONTROL FOR DC MOTOR  
FANS**



**LUCCI REMOTE FOR DC MOTOR IS  
DIFFERENT PRICE FOR DIFFERENT MODEL**



**WALL CLAMP FOR CEILING FANS  
(TO INSTALL ANY CEILING  
FAN ON WALL)**



**EXTENSION  
DOWNRODS**



**CAROLINA  
(WALL FITTED)**

**ACCESSORIES**

# OLIVIA INDUSTRIAL WALL FAN

26 inch EC industrial wall fan

**Electrical Parameter:**

BLDC Motor - DC motor without Holzer brushless,  
High performance, Fully sealed, Brushless, 6 speeds,  
9 hours timer

**Input** - 220v,50/60Hz,

**Maximum Power** - 20w-110w

**RPM** - Minimum RPM=650r/min, Maximum  
RPM=1300r/min

**Maximum Air Volume** - 250m<sup>3</sup>/min,

**Remote Control** - Hz433 RF, with learning function

Airfeel 

**Remote Control Included**



**Intelligent Control**

6 wind speed settings  
Rotary Switch Control Panel



*Customised  
Colour  
Options  
Available!*

# OLIVIA INDUSTRIAL PEDESTAL FAN

26 inch EC industrial wall fan

**Electrical Parameter:**

**BLDC Motor** - DC motor without Holzer brushless,  
High performance, Fully sealed, Brushless, 6 speeds,  
9 hours timer

**Input** - 220v,50/60Hz,

**Maximum Power** - 20w-110w

**RPM** - Minimum RPM=650r/min, Maximum  
RPM=1300r/min

**Maximum Air Volume** - 250m<sup>3</sup>/min,

**Remote Control** - Hz433 RF, with learning function

**Manual Control** - Knob Type

Airfeel 

**Remote Control Included**



**Height - 145-160cm**

**Intelligent Control**

6 wind speed settings  
Rotary Switch Control Panel



# OLIVIA INDUSTRIAL MIST FAN

**Fully sealed BLDC Brushless Motor**

**Maximum Power - 110W (Fan Only)**

210W (With Mist On)

**Voltage - 120V,60Hz / 220-240V, 50-60Hz**

**RPM - Minimum RPM=650r/min,**

Maximum RPM=1300r/min

**Maximum Air Volume - 256m<sup>3</sup>/min,**

**Remote Control - Multi-Function Controller**

**Manual Control - Knob Type**

**Grill - Spiral Grill**

**Blade - 3 Aluminum Blades**

**Water tank volume - 42 Liters**

**Continuous spray - 9 Hours**

Airfeel 

**Remote Control  
Included**



# OLIVIA SMART DC FANS

18 Blades Patented Design  
Mute Technique

**Fully sealed BLDC Brushless Motor**

**Maximum Power** - 3w-75w

**RPM** - Minimum RPM=200r/min,

Maximum RPM=850r/min

**Maximum Air Volume** - 170m<sup>3</sup>/min,

**Remote Control** - Hz433 RF, with learning function

**Manual Control** - Knob Type (Except for Wall Fan)

**Grill** - 18 inch 12 lines strong grill (pass the finger testing)

**Blade** - 18 inch 18 blades design (lowest noise, max air volume) noise 56db

Airfeel 

*Remote Control  
Included*

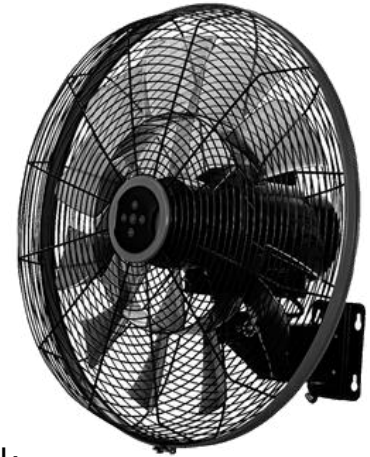

Black

## OLIVIA WALL FAN

*Customised  
Colour  
Options  
Available!*



*Remote Control  
Included*



## OLIVIA FLOOR FAN

Black



*Remote Control  
Included*



## OLIVIA PEDESTAL FAN

Black

# OLIVIA SMART DC FANS



Black



## OLIVIA WATERPROOF WALL FAN 20"

**Fully sealed BLDC Brushless Motor**

**Maximum Power** - 135W

**Voltage** - 200-240, 50/60Hz

**RPM** - Minimum RPM=650r/min,

**Speed** - 6 wind speed setting

**Timer** - Timer 9 hours

**Remote Control** - Hz433 RF,

**Waterproof** - IP 44 waterproof rating

**Blade** - 5 Aluminium blades

Airfeel 

**Remote Control  
Included**



# OLIVIA SMART DC FANS

18 Blades Patented Design  
Mute Technique

## Intelligent Control

6 wind speed settings

Rotary Switch Control Panel



## OLIVIA TWIN PEDESTAL FAN

**Fully sealed BLDC Brushless Motor**

**Maximum Power**

1st motor 3w-75w,

2nd motor 3w-75w, total 150w

**RPM** - Minimum RPM=200r/min,

Maximum RPM=850r/min

**Maximum Air Volume**

1st motor 170m<sup>3</sup>/min,

2nd motor 170m<sup>3</sup>/min, total 340m<sup>3</sup>/min

**Remote Control** - Hz433 RF,

**Manual Control** - Knob Type

**Grill** - 18 inch 12 lines strong grill

(pass the finger testing)

**Blade** - 18 inch 18 blades design

(lowest noise, max air volume) noise 56db

Airfeel 

Customised  
Colour  
Options  
Available!

Remote Control  
Included

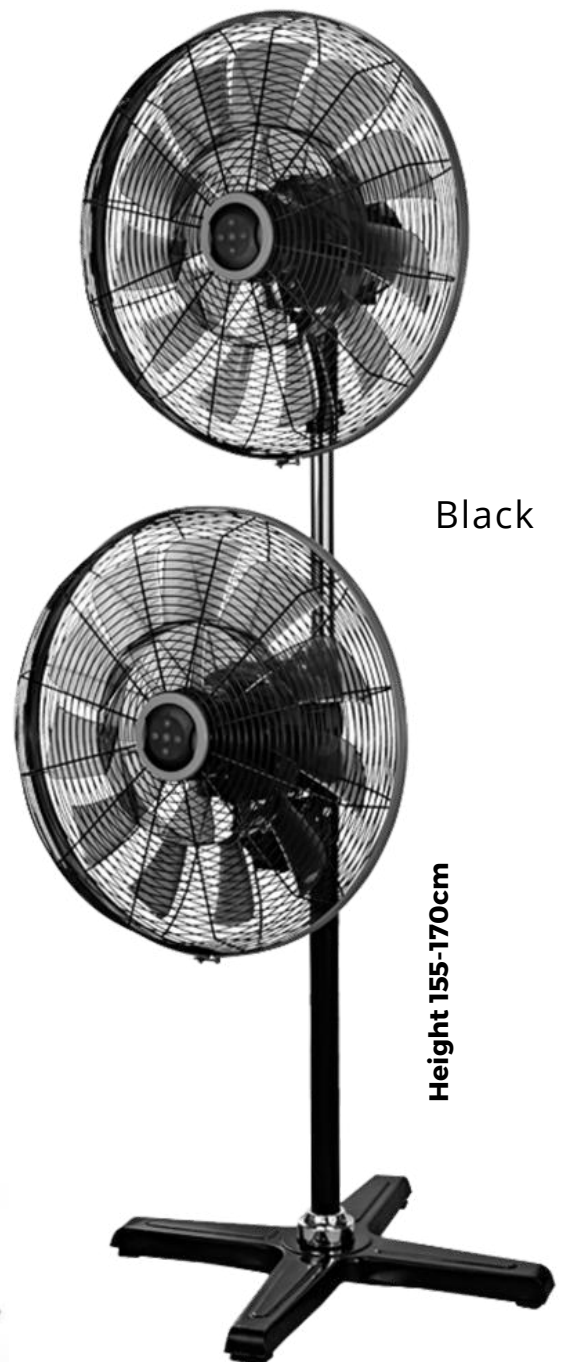

# OLIVIA SMART DC FANS

18 Blades Patented Design  
Mute Technique



Height 108-135cm

Black

Customised  
Colour  
Options  
Available!

Remote Control  
Included



### Intelligent Control

6 wind speed settings  
Rotary Switch Control Panel



## OLIVIA MIST PEDESTAL FAN

**Fully sealed BLDC Brushless Motor**

**Maximum Power** - 18w-115w (With Mist On)

**RPM** - Minimum RPM=200r/min,

Maximum RPM=850r/min

**Maximum Air Volume** - 170m<sup>3</sup>/min,

**Remote Control** - Hz433 RF,

**Manual Control** - Knob Type

**Grill** - 18 inch 12 lines strong grill

(pass the finger testing)

**Blade** - 18 inch 18 blades design

(lowest noise, max air volume) noise 56db

**Water tank volume** - 4 liters

**Continuous spray** - 8-24 hours

**Spray droplet** - 0.05-0.20mg

Airfeel 





Titanium

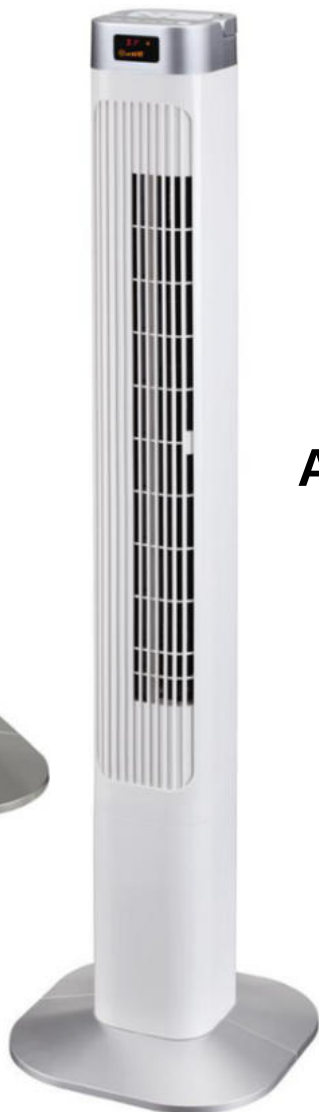

White

*Remote Control  
Included*



## ALPINE PLUS TOWER FAN 48"

**Low Noise, Powerful 65w Copper Motor  
with HEAVY & STURDY BASE**

**Full Function Simple LED Display**

**3 Winds Mode Setting (Normal / Natural / Sleep)**

**3 Speeds Setting / Wind Speed 8m/s**

**90 Oscillation(Left and Right)**

**Remote Control**

**12 Hours Pre-set Off Timer**

**Fresh Air Ionizer**

**With Room Temperature Display**

**Space Saving Sleek Design**

Airfeel  

*Remote Control  
Included*



## ALPINE GRAND 48"

1. Low Noise, Powerful 40w Copper Motor
2. 3 Speed Setting / Wind Speed 6m/s
3. Timer & Remote Controlled Operation
4. 90 Degree Oscillation
5. Space Saving Sleek Design

Airfeel 

**STOCK CLEARANCE**



White

## VENTIANA EXHAUST

DIMENSIONS	AIR DELIVERY	NOISE LEVEL
4" Cutout 98 mm	4" 70 M3 / H	4" - 30 DB
Outer body 150 mm x 140 mm	6" 210 M3 / H	6" - 35 DB
Depth 72 mm	8" 370 M3 / H	8" - 39 DB
6" Cutout 145 mm		
Outer body 200 mm x 190 mm	<b>MOTOR POWER</b>	<b>RPM</b>
Depth 93 mm	4" - 15W	4" - 2450
8" Cutout 195 mm	6" - 25W	6" - 2080
Outer body 268 mm x 255 mm	8" - 25W	8" - 1700
Depth 129 mm		



- Engineering PP Plastic.
- Elegant Design and Low Noise.
- Silicon Steel Motor.
- 100% pure copper winding.
- Built in Thermo cut off for Motor Protection.
- Universal Design for Ceiling/ Glass / Wall.
- Anti-Mosquito and Anti-Rodent Rear Shutters.

SIZE AVAILABLE | COLOURS AVAILABLE  
4, 6 & 8 Inches | White (in 6" Only)



## Stainless Steel Panel (SS304)

- Engineering PP Plastic.
- Elegant Design and Low Noise.
- Silicon Steel Motor.
- 100% pure copper winding.
- Built in Thermo cut off for Motor Protection.
- Universal Design for Ceiling/ Glass / Wall.
- Anti-Mosquito and Anti-Rodent Rear Shutters.



## BREZA II EXHAUST

DIMENSIONS	AIR DELIVERY	NOISE LEVEL
6" Cutout 145 mm	210 M3 / H	35 DB
Outer body 200 mm x 190 mm	<b>MOTOR POWER</b>	<b>RPM</b>
Depth 93 mm	25W	2080

SIZE AVAILABLE | COLOURS AVAILABLE  
6 Inches | Steel/Grey



## ZEPHYR EXHAUST FAN

DIMENSIONS	AIR DELIVERY	NOISE LEVEL
Cutout 150 mm	210 M3 / H	35 DB
Outer body 204 mm x 204 mm	<b>MOTOR POWER</b>	<b>RPM</b>
Depth 108 mm	25W	1800

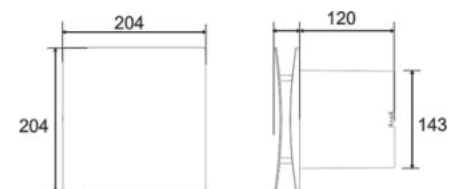

- Universal design for ceiling/glass or wall mount
- Modern fascia
- Long life premium motor
- Easy to install and clean
- Anti mosquito rear shutters

SIZE AVAILABLE | COLOURS AVAILABLE  
6 Inches | White



- Engineering PP Plastic.
- Elegant Design and Low Noise.
- Silicon Steel Motor.
- 100% pure copper winding.
- Built in Thermo cut off for Motor Protection.
- Universal Design for Ceiling/ Glass / Wall.
- Anti-Mosquito and Anti-Rodent Rear Shutters.

SIZE AVAILABLE | COLOURS AVAILABLE  
4 & 6 Inches | White | Black

### VIPER EXHAUST

DIMENSIONS	AIR DELIVERY	NOISE LEVEL
4" Cutout 100 mm	4" 100 M3 / H	4" - 33 DB
Outer body 148 mm x 148 mm	6" 300 M3 / H	6" - 37 DB
Depth 85 mm		
6" Cutout 150 mm		
Outer body 215 mm x 215 mm	4" - 15W	4" - 2450
Depth 111 mm	6" - 25W	6" - 2250



- Engineering PP Plastic.
- Elegant Design and Low Noise.
- Silicon Steel Motor.
- 100% pure copper winding.
- Built in Thermo cut off for Motor Protection.
- Universal Design for Wall / Glass / Ceiling
- Anti-Mosquito and Anti-Rodent Rear Shutters.

SIZE AVAILABLE | COLOURS AVAILABLE  
8 Inches | Off - White

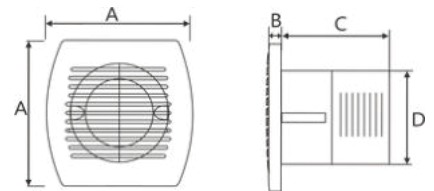

	A	B	C	D
<b>EXW-B8</b>	257mm	8mm	129mm	196mm

### WIND EXHAUST

DIMENSIONS	AIR DELIVERY	NOISE LEVEL
8" Cutout 196 mm	370 M3 / H	39 DB
Outer body 257 mm x 257 mm		
Depth 129 mm		
	MOTOR POWER	RPM
	25W	1700

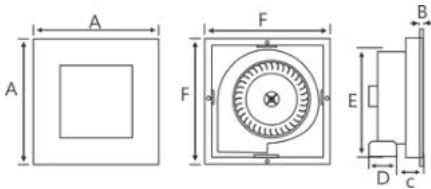

A	B	C	D	E	F
270mm	5mm	40mm	98mm	215mm	265mm



- Engineering PP Plastic.
- Elegant Design and Low Noise.
- Silicon Steel Motor.
- 100% pure copper winding.
- Built in Thermo cut off for Motor Protection.
- Specially Designed for Ceiling.
- Anti-Mosquito and Anti-Rodent Rear Shutters.

SIZE AVAILABLE | COLOURS AVAILABLE  
270 mm x 270 mm | Off - White

## ELIZA CEILING EXHAUST

DIMENSIONS	AIR DELIVERY	NOISE LEVEL
Cutout 228 mm	200 M3 / H	40 DB
Outer body 270 mm x 270 mm	MOTOR POWER	RPM
Depth 149 mm	24W	1700

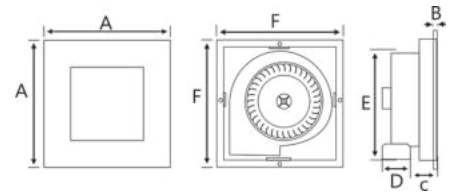

## ELIZA-BTS



DIMENSIONS	AIR DELIVERY	NOISE LEVEL
6" Cutout 145 mm	200 M3 / H	40 DB
Outer body 200 mm x 190 mm	MOTOR POWER	RPM
Depth 93 mm	24W	2080

- Universal design for ceiling
- Modern fascia
- Long life premium motor
- Easy to install and clean
- Built in Bluetooth Speaker

SIZE AVAILABLE | COLOURS AVAILABLE  
270mm x 270mm | White  
4" Outlet



## ELIZA-PRO

DIMENSIONS	AIR DELIVERY	NOISE LEVEL
Cutout 100 mm	200 M3 / H	35 DB
Outer body 204 mm x 204 mm	MOTOR POWER	RPM
Depth 108 mm	24W	1350

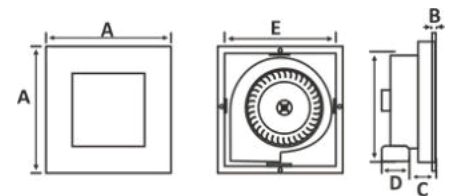

A	B	C	D	E
270mm	15mm	24mm	98mm	228mm

- Universal design for ceiling
- Modern fascia
- Long life premium motor
- Easy to install and clean
- Built in Bluetooth Speaker

SIZE AVAILABLE | COLOURS AVAILABLE  
270mm x 270mm | White  
4" Outlet



- Engineering PP Plastic.
- Elegant Design and Low Noise.
- Silicon Steel Motor.
- 100% pure copper winding.
- Built in Thermo cut off for Motor Protection.
- Universal Design for Ceiling/ Glass / Wall.
- Anti-Mosquito and Anti-Rodent Rear Shutters.

SIZE AVAILABLE | COLOURS AVAILABLE  
6 Inches | Glass - White | Glass - Black

### ZENVO EXHAUST

DIMENSIONS	AIR DELIVERY	NOISE LEVEL
6" Cutout 150 mm	6" 210 M3 / H	35 DB
Outer body 211 mm x 191 mm	MOTOR POWER	RPM
Depth 109 mm	25W	2080



- Engineering PP Plastic.
- Elegant Design and Low Noise.
- Silicon Steel Motor.
- 100% pure copper winding.
- Built in Thermo cut off for Motor Protection.

SIZE AVAILABLE | COLOURS AVAILABLE  
4 & 6 Inches | White



DIMENSIONS	HEIGHT	WIDTH	DEPTH
4"	270MM	200MM	600MM
6"	290MM	225MM	500MM

### VANTAGE SUPER SILENT

AIR DELIVERY	NOISE LEVEL	MOTOR POWER	RPM
4" 210 M3 / H	4" - 24 DB	4" - 25W	4" - 2450
6" 520 M3 / H	6" - 24 DB	6" - 55W	6" - 2550

	A	B	C	D	E
4"	297mm	234mm	177mm	22mm	97mm
6"	307mm	256mm	200mm	78mm	145mm

## VANTAGE MIXFLOW INLINE EXHAUST

AIR DELIVERY	NOISE LEVEL	MOTOR POWER	RPM
4" 210 M3 / H	4" - 41 DB	4" - 35W	4" - 2450
6" 520 M3 / H	6" - 45 DB	6" - 60W	6" - 2550
8" 820 M3 / H	8" - 59 DB	8" - 120W	8" - 2500

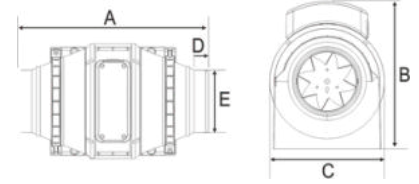

- Engineering PP Plastic.
- Elegant Design and Low Noise.
- Silicon Steel Motor.
- 100% pure copper winding.
- Built in Thermo cut off for Motor Protection.

SIZE AVAILABLE | COLOURS AVAILABLE  
4 6 & 8 Inches | Off - White

## ACCESSORIES

ALUMINIUM COIL		INLET GRILL		MOTION SENSOR FOR EXHAUST	INLET GRILL WITH LIGHT
6 Inches	4 Inches				
5 Mtrs 10 Mtrs	5 Mtrs 10 Mtrs	6 Inches 4 Inches	4 Inches Disc 6 Inches Disc		4 Inches

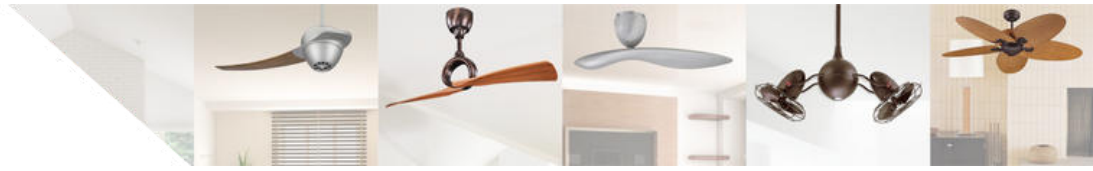

## WHY USE AN EXHAUST FAN?

There are 3 main reasons as to use exhaust fans:

To remove impurities in the air (moisture, smells, smoke, heat etc)

To encourage air circulation within an area

To transfer tempered (warm/cool) air from one place to another

These factors play a part in determining which exhaust fan will be suitable for the desired application. It can also be used to help eliminate condensation and mould in moisture exposed spaces.

This is a general guide to the majority of exhaust fans.

The steps required in picking out the correct exhaust fan are:

Determine what variant of exhaust is required and how it will be mounted (eg wall, ceiling, window etc)

Calculate the area being exhausted (Length x Width x Height). This will give you a figure in m<sup>3</sup> (cubic meters)

Multiply this with the number of air-changes required (8 for a subfloor/meeting area, 13-15 for a bathroom or toilet, 15+ for smoke exhaust). If you like to have long, hot showers or are concerned about steaming up the bathroom then please use a figure of 15-20 air changes per hour

Determine whether to duct directly into the roof space, or through a wall.

### Kinds of Inline fans

**Mixflow Inline Fans:** Mixed Flow Inline exhaust fans are a mixture between the Axial and Centrifugal models. They have good airflow and good pressure characteristics, can be used for longer runs of duct, bends, branches, etc. They show centrifugal fan characteristics from a size of 150mm upwards and axial fan characteristics for sizes smaller than 150mm.

Well Suited Applications for a Mix Flow Motor

Medium/Large bathroom, ensuite or laundry

Installation that has a moderate amount of ducting (from 0-20 meters approx)

**Axial Inline Fans:** Axial fan motors are generally suited to applications that require high extraction at a low pressure. Low pressure means that the fan is not particularly well suited when a long duct run is needed.

Well suited Applications for an Axial motor

A small toilet

A small bathroom, ensuite or laundry

An installation that has minimal ducting (less than a few meters).

### **Centrifugal Inline Fans:**

A centrifugal extraction fan motor is the opposite to an axial motor in terms of its characteristics when dealing with pressure.

The centrifugal motor has been engineered to operate with long duct runs which may have bends, junctions and multiple inlets/outlets.

Well suited Applications for a Centrifugal motor

Large heat transfer systems

Large Sub floor ventilation systems

Servicing a large area

An installation that has a vast amount of ducting (20 meters or more)

HOW TO SELECT EXHAUST FAN		Recommended Air Changes															
<p>1. Calculate the room volume : Length x Width x Height Eg. A Bathroom that is 3m by 2m and 2.5m high = 15m<sup>3</sup></p> <p>2. Calculate required air movement: <b>Room Volume x Recommended Air Changes</b> Eg. 15m<sup>3</sup> bathroom with 10 changes per hour is 15x10=150m<sup>3</sup>/h</p>	<p>So you have to select an exhaust fan with Air delivery of 150m<sup>3</sup>/h or greater.</p> 	<table border="1"> <thead> <tr> <th>RESIDENTIAL PREMISES</th> <th>PREMISE TYPE</th> <th>RECOMMENDED AIR CHANGES PER HOUR</th> </tr> </thead> <tbody> <tr> <td></td> <td>Kitchen</td> <td>10</td> </tr> <tr> <td></td> <td>Bathroom</td> <td>12</td> </tr> <tr> <td></td> <td>Large Bathroom</td> <td>10</td> </tr> <tr> <td></td> <td>Toilet / Powder Room</td> <td>10</td> </tr> </tbody> </table>	RESIDENTIAL PREMISES	PREMISE TYPE	RECOMMENDED AIR CHANGES PER HOUR		Kitchen	10		Bathroom	12		Large Bathroom	10		Toilet / Powder Room	10
RESIDENTIAL PREMISES	PREMISE TYPE	RECOMMENDED AIR CHANGES PER HOUR															
	Kitchen	10															
	Bathroom	12															
	Large Bathroom	10															
	Toilet / Powder Room	10															

# L U F T<sup>®</sup>

QUALITY IS NOT EXPENSIVE IT'S PRICELESS

*presenting*

## FUSION CURTAIN MOTOR

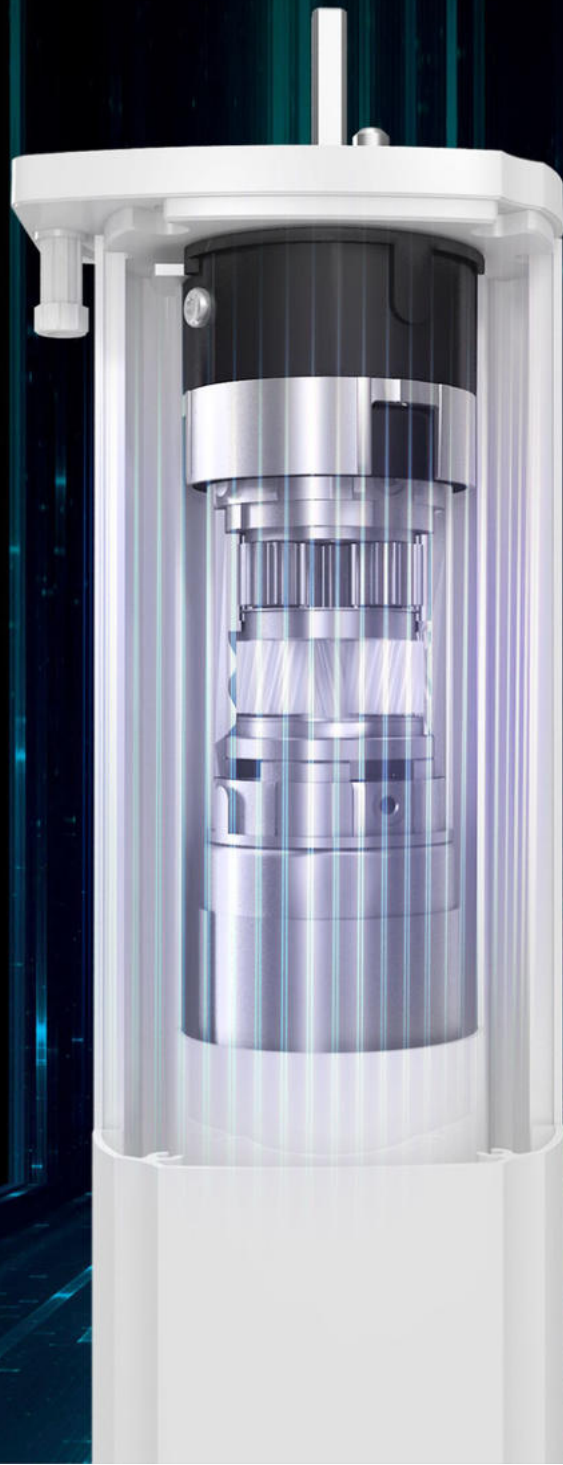



LÜFT®  
ULTRA-QUIET MOTOR COLLECTION

**INDOOR MOTORIZED SHADES SOLUTIONS**

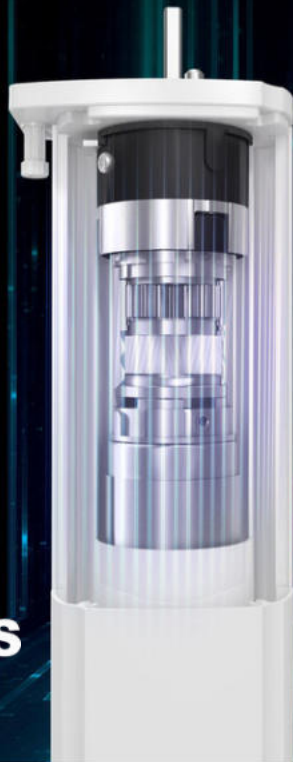

Fusion Curtain Motor comes with advanced technology for Heavier load and quiet operation. It is flexible for manual switch operation meant for automation or wireless remote operation.

PRODUCT NAME	MODEL	RATED TORQUE	SPEED	MOTOR SIZE	RATED VOLTAGE	RATED POWER	IP CLASS
Fusion Curtain Motor (Five Wires)	FCM175	1.5Nm	16cm/s	316x68x53mm (L) (W) (H)	AC100-240V 50/60HZ	65W upto 60kgs	IP20

### FEATURES

- Stop on block
- Soft start and soft stop
- Automatic Limit setting memory
- Flexible super silent design
- Various control options
- Wide Voltage power supply
- Group control
- Fabric rebound journey correction
- Pull to go
- Over-voltage protection
- Manual Switch function

### WIRING INSTRUCTIONS

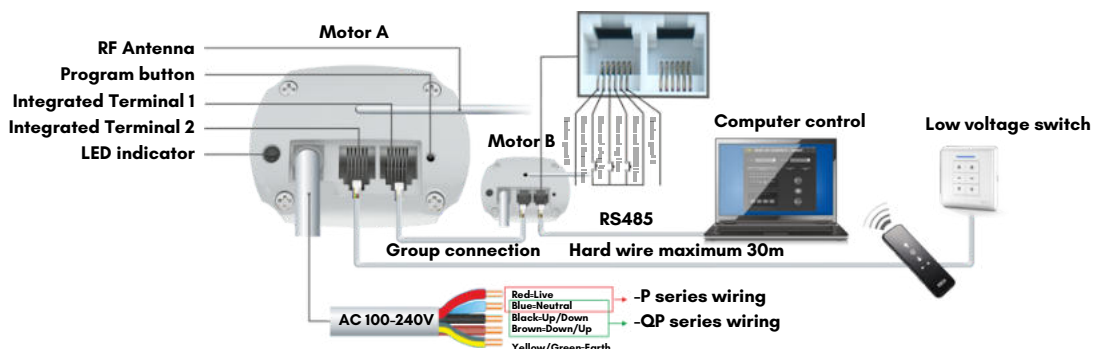

# PREMIUM CURTAIN MOTOR

Using our new generation  
Helical Gearbox Design,  
Fusion Curtain Motor is more  
Powerful & Quiet.





# REMOTES & ACCESSORIES

LMR-101  
SINGLE CHANNEL



LMR-102  
DOUBLE CHANNEL



LMR-106  
SIX CHANNEL



LMR-101 LMR-102 LMR-106

## FEATURES

- ✓ Luxurious piano lacquer, Anti-scratch surface treatment
- ✓ Low battery consumption.
- ✓ Simple design with touch screen.
- ✓ Advanced touch technology.
- ✓ Cr2032 button battery, can be easily replaced.
- ✓ Battery last for 2-3 years.

# PERSONALISED CEILING FANS



personalising  
a product  
according to  
your needs &  
preferences.  
More colors,  
more styles,  
more you

**NEXT IS  
WHAT...**

LÜFT.  
Create



# Personalised Ceiling Fans

Next is What...



**SCUDERIA AB GREEN**

LÜFT.  
Create



# Personalised Ceiling Fans

Next is What...



**ATLANTA BLACK GOLD**

LÜFT.  
Create

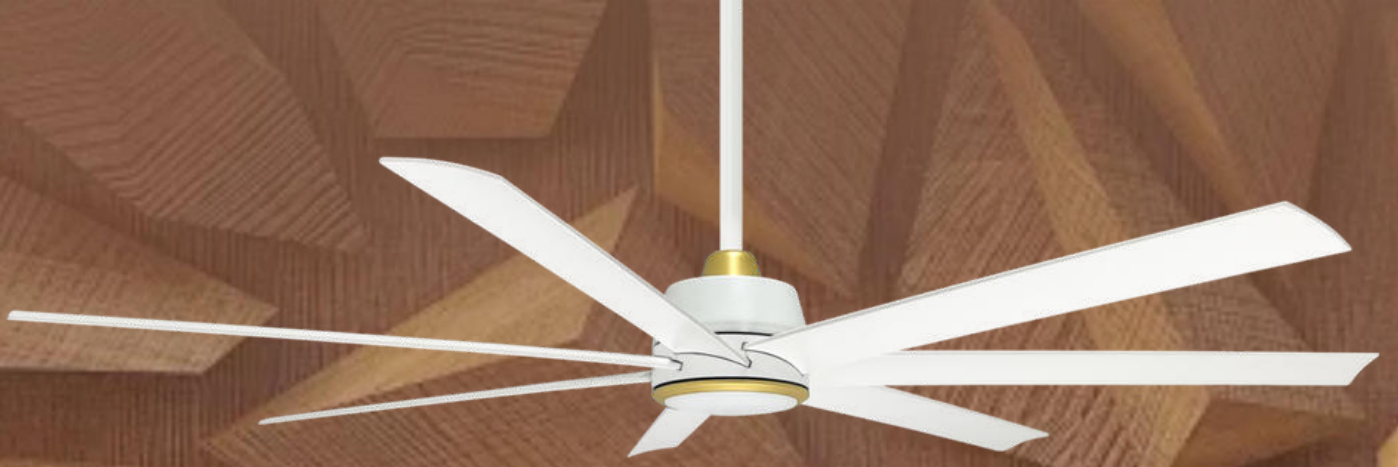

*Personalised Ceiling Fans*

Next is What...



**ATLANTA WHITE GOLD**

LÜFT.  
Create

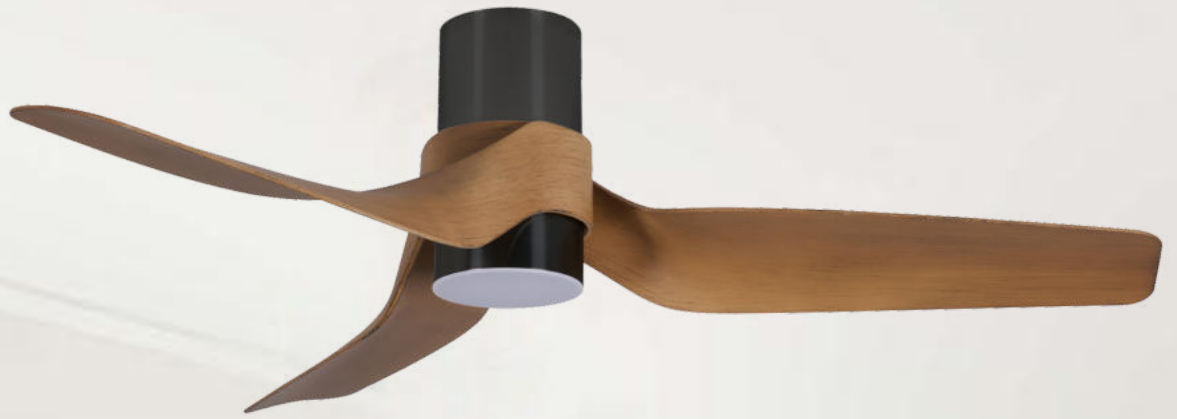

# Personalised Ceiling Fans

Next is What...

**NAUTICA BLACK TEAK**

LÜFT.  
Create



# Personalised Ceiling Fans

Next is What...

**DAYTONA BLUE BRASS**

LÜFT.  
Create



*Personalised Ceiling Fans*

Next is What...

**CITRON II BLUE BRASS**

LÜFT.  
Create



SCAN QR CODE TO DOWNLOAD E-CATALOGUE

All products are manufactured in China for

**Luft International**  
92 Latitude Promenade  
Truganina, Victoria-3029  
Australia

Authorized Distributor

[www.luft.co.in](http://www.luft.co.in)